

**Anritsu** envision : ensure

# Radio Communication Test Station

## MT8000A



# All-in-One 5G NR RF Measurements, Protocol Tests and Functional Tests

# 5G

**5G, Official Start**

Anritsu is releasing its new platform for developing 5G communications terminals, chipsets and devices.

With support for both RF measurements and protocol tests, this all-in-one platform can be configured easily for various tests, including RF measurements, protocol and functional tests matching the module construction.

Anritsu — the leader in 4G testing — is also now taking the lead in 5G.



## Flexibility

### Measurement Module Configurations Matching Test Application

The all-in-one MT8000A supports RF measurements, protocol and function tests with a single unit while its flexible expandability not only meets future wider application needs but also helps cut-back new instrument investment and training costs for more efficient cost-performance.

## FR1 (to 7.125 GHz) — FR2

### Comprehensive Test Coverage from mmWave RF Measurements to Beamforming Tests

As well as supporting the FR1 (to 7.125 GHz) used by 5G, combining the MT8000A with OTA chambers also supports the FR2 (mmWave band) RF measurements and beamforming tests.

# MT8000A



## Software

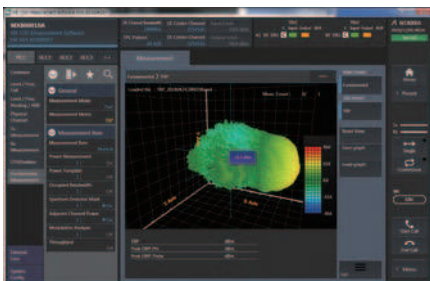

RF Measurement Software

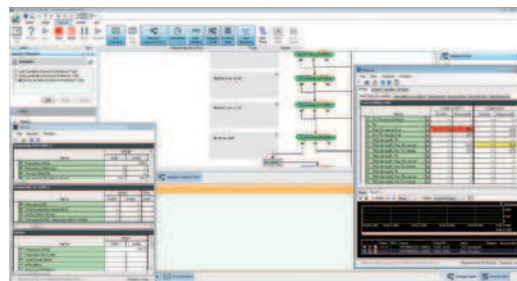

RTD for 5G NR

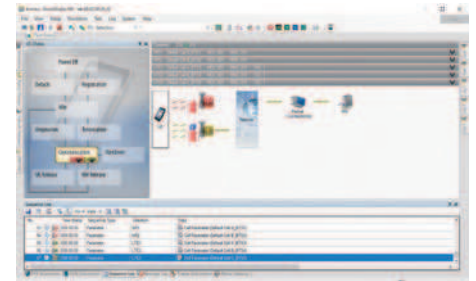

Function and Application Tests Software:  
SmartStudio NR

\*: The design, explanation and appearance are subject to change without notice.



# The Wireless Communication Test Station for 5G Device Development

## Radio Communication Test Station MT8000A Features

### All-in-One Support for RF Measurements and Protocol Tests in FR1 (to 7.125 GHz) and Millimeter Wave Bands

With a 5G base station emulation function, a single MT8000A test platform supports both the FR1 (to 7.125 GHz) and the FR2 (28 GHz/39 GHz) bands used by 5G. Combining it with the RF Chamber enables both millimeter wave band RF measurements and beamforming tests using call connections specified by 3GPP.

#### Example of Supported Band

Band	n71 (600 MHz)	n41 (2.5 GHz)	n78-79 (3.5 G/4.5 GHz)	n257 (28 GHz)	n260 (39 GHz)
	✓	✓	✓	✓	✓

\*: Please enquire about other supported bands.

### Flexible Platform using Modular Architecture

Both Non-signalling and Signalling RF TRx measurements and protocol tests are supported by switching the test application at the common hardware platform.

In addition to supporting high-order MIMO (4x4 MIMO) and carrier aggregation (8CA) for implementing enhanced Mobile Broadband (eMBB), new 5G test needs, such as Ultra-Reliable and Low Latency Communications (URLLC) and massive Machine Type Communications (mMTC) are supported by the leading-edge design with flexibility and expandability based on the modular architecture.

A futureproof, flexible test environment is provided for a wide application range.

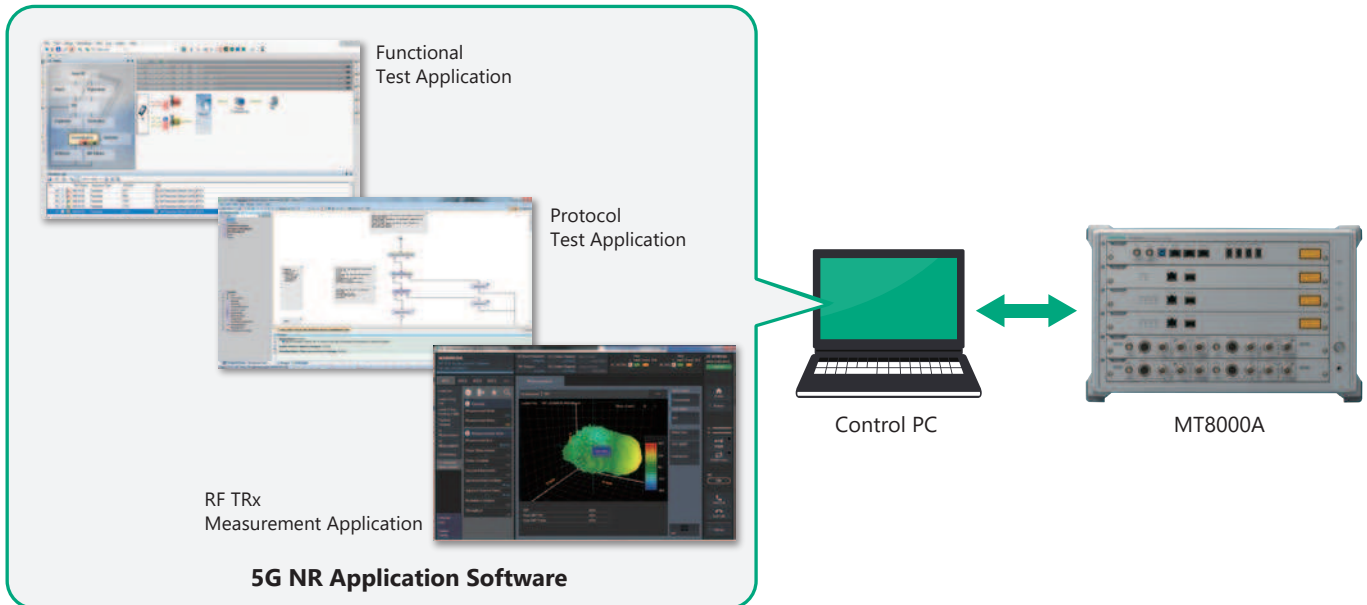

# The Wireless Communication Test Station for 5G Device Development

## Radio Communication Test Station MT8000A Features

### Supports Existing LTE Test Environment

A comprehensive test environment is provided by making use of Anritsu's LTE test platform offering leading-edge functions based on the company's long experience in this market. Easy configuration of a linked environment for simulating 5G NSA (non-standalone) with LTE makes best use of measurement assets, such as the customer's test environment, test scenarios.

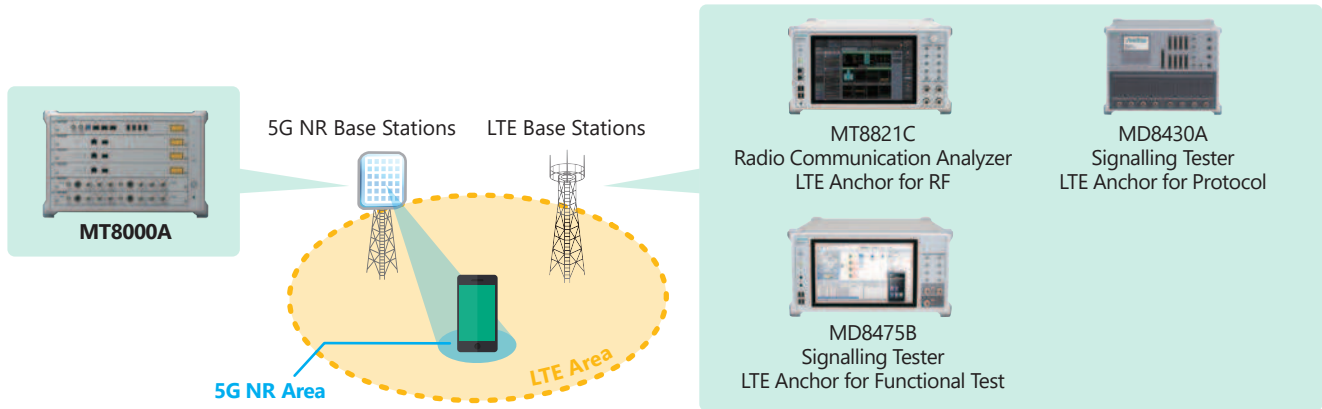

# Radio Communication Test Station MT8000A Features

## RF TRX Measurement GUI : MX800010A

### 3GPP RF Tests

Development and testing of mobile terminals and chipsets as well as network operator acceptance inspection tests, etc., are essential for evaluating compliance of the mobile terminal TRx performance with the 3GPP standards. With the increasing complexity of mobile terminal circuitry due to the use of more frequency bands, such as mmWave, the MX800010A software is an ideal solution for testing various aspects in support of 5G NR Mobile terminal RF TRx tests.

### Flexible Parameter Settings

The easy to change MX800010A parameter settings also support RF parametric tests and simplified protocol tests.

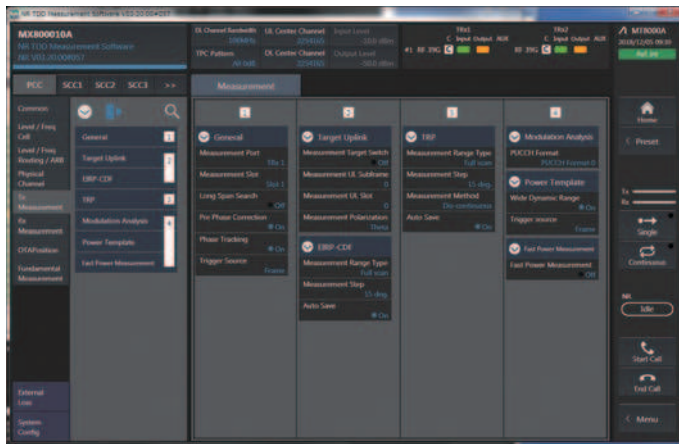

Typical Parameters (5G NR)

### Supports Tests in NSA Mode

The 5G NR non-standalone (NSA) mode is supported and the Radio Communication Analyzer MT8821C can be used as an LTE Anchor in the NSA mode.

### Enhanced GUI for Efficient Operability

The MX800010A has the same easy to use and easy to understand GUI as the MT8821C. In addition to one-touch switching of listed and individual graph displays as well as summary and detailed displays of measurement results, the MX800010A supports convenient parameter setting functions such as, parameter searching and bookmarking for frequently used parameters.

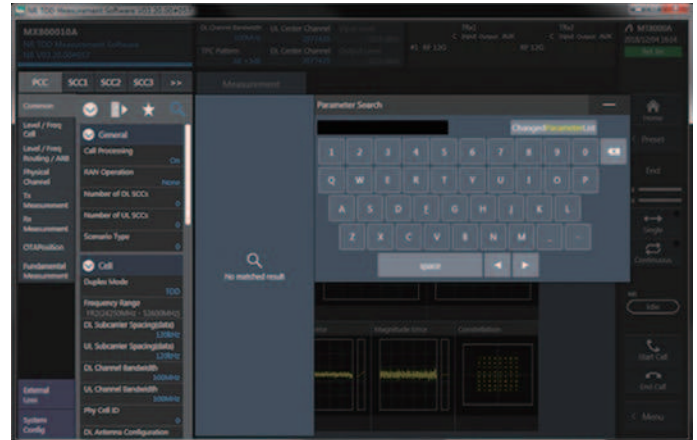

Parameter Search Function



Graph Display

# Radio Communication Test Station MT8000A Features

## RF TRX Measurement GUI : MX800010A

### OTA (Over The Air) Tests

OTA evaluation is required because the TRx performance of mobile terminals is influenced by factors such as the terminal form and antenna characteristics, etc.

There are two main types of 5G NR OTA test as follows:

- mmWave RF TRx Test
- Evaluating Mobile Terminal General TRx Performance Including Antenna

#### <mmWave RF TRx Test>

Since 5G NR uses an antenna array for sending and receiving signals in the mmWave band, evaluation of the RF TRx performance is performed using an OTA connection without an RF cable connection like that for LTE. Anritsu provides a turnkey mmWave RF TRx measurement solution including the RF chamber.

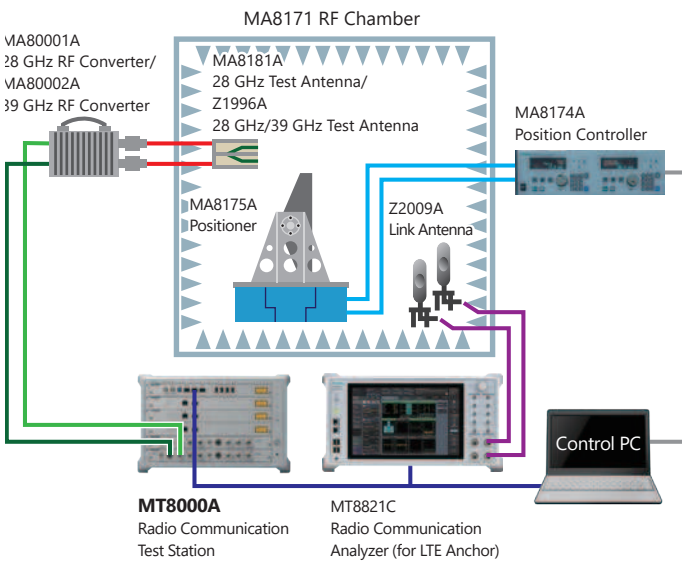

mmWave RF TRx Measurement Environment

#### <Evaluating Mobile Terminal General TRx Performance Including Antenna>

There are two antenna test methods: Total Radiated Power (TRP), and Total Radiated Sensitivity (TRS); various test systems using the MT8000A are available from OTA vendors.

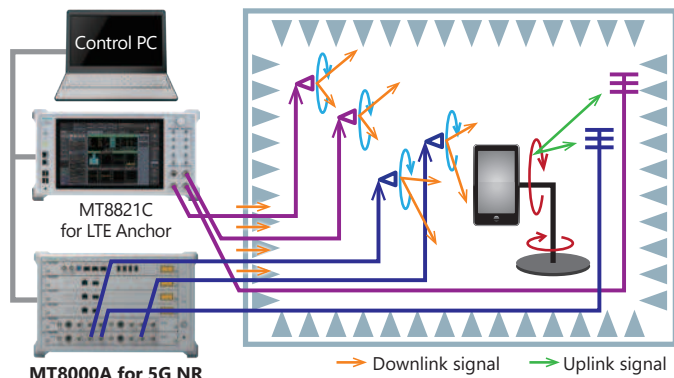

Radiowave Anechoic Chamber

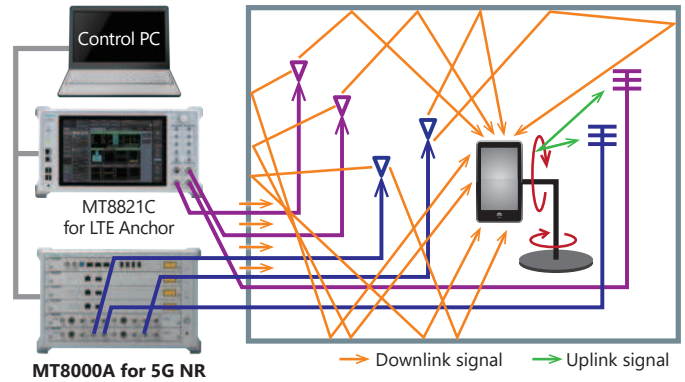

Reverberation Chamber

### SAR (Specific Absorption Rate) Test

The SAR test evaluates the amount of energy in the electromagnetic spectrum radiated from the mobile terminal absorbed by a jig known as a 'phantom', mimicking the human body. The purpose of this test is to help protect handheld users from adverse effects of electromagnetic waves on health. The specified amount of permissible absorbed energy is regulated by national and regional standards. The MT8000A fully supports 5G NR SAR tests.

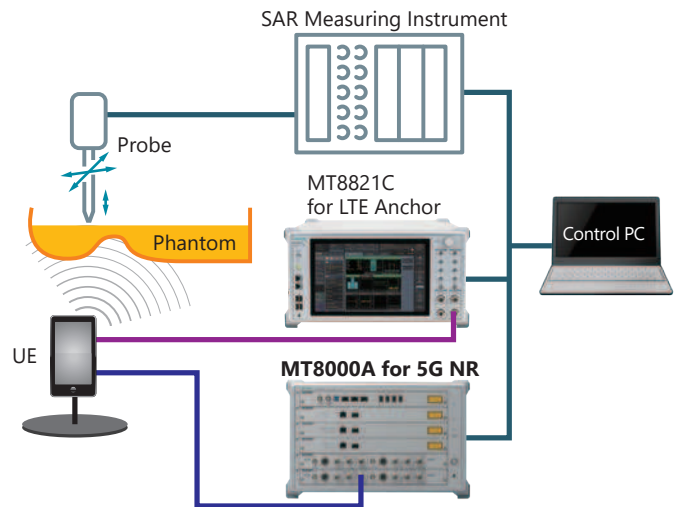

SAR Test Configuration

# Radio Communication Test Station MT8000A Features

## NR Protocol Test Solutions

### Encoding/Decoding Test

The 5G NR terminal encoding/decoding test is performed by connecting the equipment as follows using an RF cable.

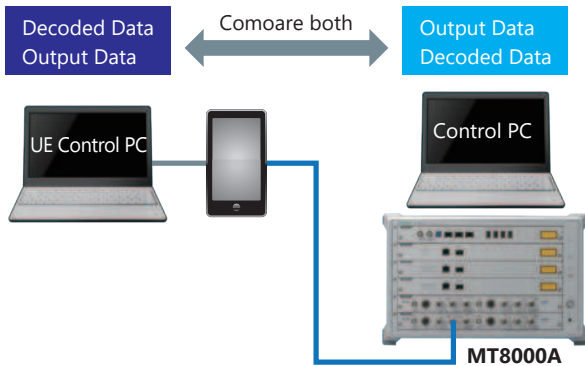

Encoding/Decoding Test Configuration (RF, Serial Control Test)

The Rapid Test Designer Platform (RTD) MX800050A and the NR Protocol Firmware MX800051A have built-in support for the digital baseband input/output function. Using the function supports high-reproducibility encoding/decoding tests without dependence on the performance of the RF section for stable baseband evaluation of 5G NR chipsets. In addition, 5G NR encoding/decoding tests are performed certainly because the baseband chip is evaluated at a slow clock below the clock frequency.

### Cuts Test Case Developer Training

With a full range of test procedures for Layer 1/2 and Layer 3 tests, the RTD software eliminates the need for specialist knowledge about TTCN code and unique simulator APIs, etc. Moreover, each procedure automatically sets the Layer 1/2 (L1/L2) connection conditions based on the complex 3GPP standards. Since the MD8430A can be controlled directly, 5G NR and LTE NSA test environments can be configured easily. Furthermore, the full range of available reference test samples with confirmed connections supports development of test cases using a library.

### Shortens Test Case Development Time

The RTD GUI makes it easy to create test cases using intuitive operations to connect procedures. Additionally, each procedure has a screen for setting various parameters, such as network conditions and message information, to increase test case variations using simple operation. Lastly, an analysis function checks for program mistakes prior to testing, and any code edits or changes are reflected immediately in the executed test.

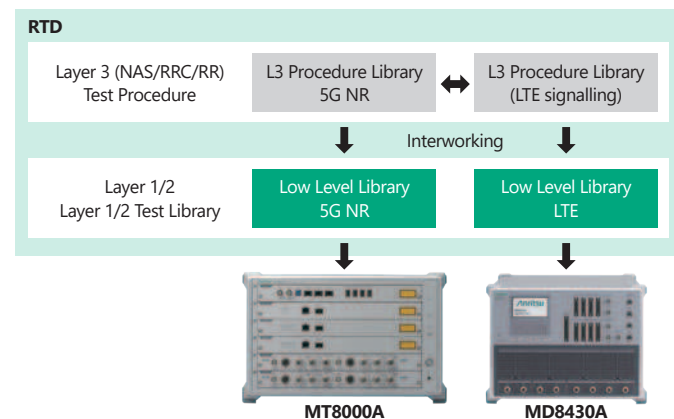

RTD Procedure Block

### Efficient Execution, Evaluation and Analysis

Test sequences can be confirmed in real-time during test execution and completed test results can be confirmed at a glance because Pass/Fail evaluations are defined within the test case. Moreover, detailed analysis is supported by integration of an HTML-based protocol analyzer with the RTD. Additionally, export of logs into HTML enables logs to be opened on any PC in the same manner as the protocol analyzer.

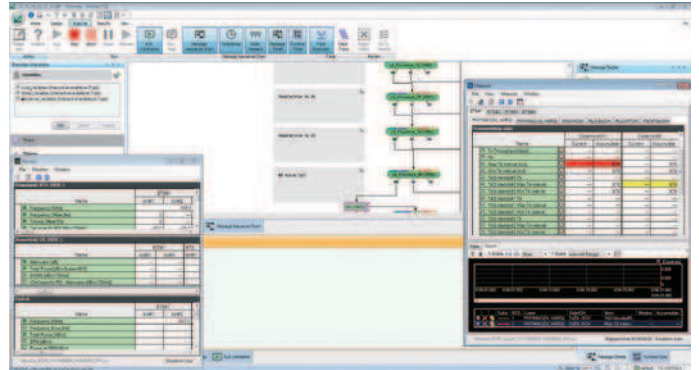

Test Execution Screen (RTD)

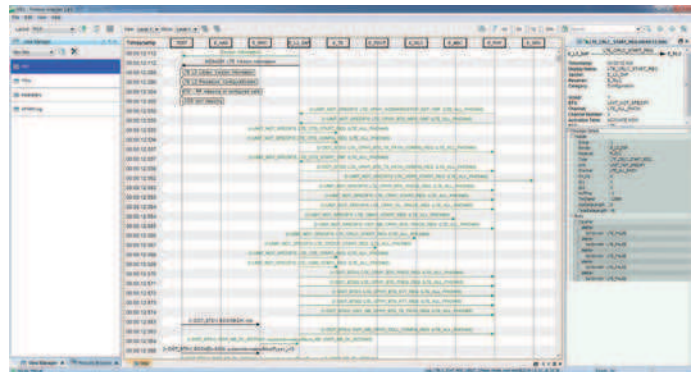

Log Analysis Screen (RTD)



# Radio Communication Test Station MT8000A Features

## NR Protocol Test Solutions

### Throughput Tests at Various Conditions

Combining the MX800030A with the Data Test Module MT8000A-012 supports IP throughput tests. Sample scenarios bundled with the software can be used to change parameters, such as bandwidth, scheduling, HARQ, etc., easily for running 5G NR IP throughput tests under various conditions.

### Handover Tests at Various Conditions

With support for up to 8 cells, handover tests between 5G NR 4CA cells are possible using only one MT8000A. Moreover, installing the Multi Box Data Connection MT8000A-009 option in the MT8000A enables up to 8CA 2x2 MIMO handover tests by connecting two MT8000A units. Lastly, combined use with the Signalling Tester MD8430A supports LTE interworking, helping maximize customers' investment in their existing hardware.

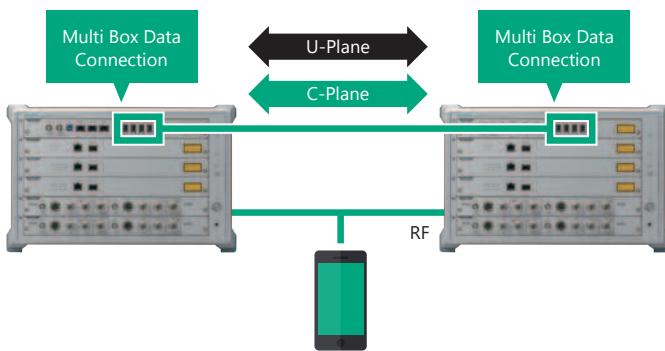

### Fully Versatile L1/L2 Monitoring Functions

To support the development of 5G terminals that process large volumes of low-layer data at very high speeds, the software enhances a full line of versatile power monitoring, throughput monitoring and log analysis functions. The Measure (Counter) functions can monitor Layer 1/2 (L1/L2) throughputs in real time by counting parameter values such as ACK/NACK/DTX/CQI.

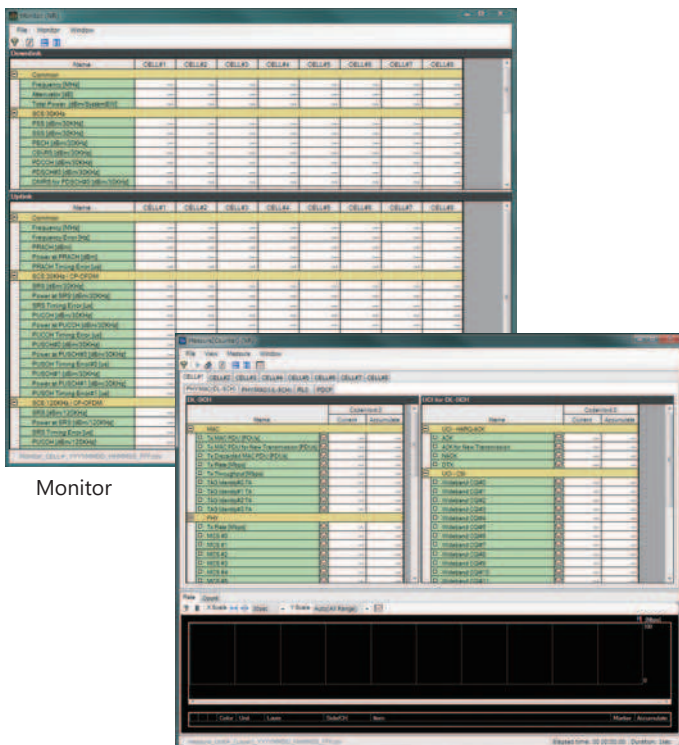

Measure (Counter, Throughput Monitor)

### Powerful Test Automation

With support for mobile terminal control interfaces, the RTD software simplifies test automation. In addition, continuous multiple test case execution and automatic test report creation as well as various functions including repeat operation for a set number of times provide powerful support for automated testing.

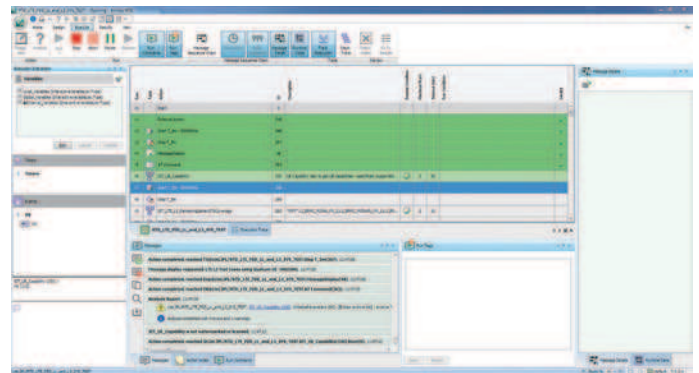

Example of Continuous Test Case Execution

### Easy Test Case Maintenance

Test cases created using the RTD software are easily updated for new 3GPP standard releases, helping cut test-case editing workloads. Moreover, recompiling is unnecessary because test cases maintain compatibility even after firmware updates. Consequently, test-case maintenance costs at commercial release of new mobile terminals are greatly reduced for pre-inspection regression tests and interoperability tests (IOT) with networking equipment.

### 5G NR Fading Tests

In cooperation with a fading PC, it supports fading tests by imposing fading on downlink signals up to 4CA 2x2 MIMO or 2CA 4x4 MIMO using just one MT8000A. It supports 5G NR Channel Model (TDL) compliant with 3GPP TS 38.521. The channel models can be edited as necessary.

# Radio Communication Test Station MT8000A Features

## Functional and Regression Tests for 5G devices: SmartStudio NR MX800070A

### 5G Terminal Functional Tests

With an interactive GUI, SmartStudio NR MX800070A supports FR1/FR2 UE call connections, IP throughput tests, and IMS VoLTE testing, as well as Internet connections, live server application tests, and various mobility tests without requiring difficult scenario development. Moreover, user-generated test cases can be executed automatically using the SmartStudio Manager external control tool or an external control interface.

### Interactive GUI

The easy-to-use interactive GUI requires no knowledge of high-level protocols, and the current UE real-time status is displayed on the UE Status screen along with detailed protocol messages and sequences under the Log Display screen. Additionally, PDN settings, creation of test cases, etc., are supported.

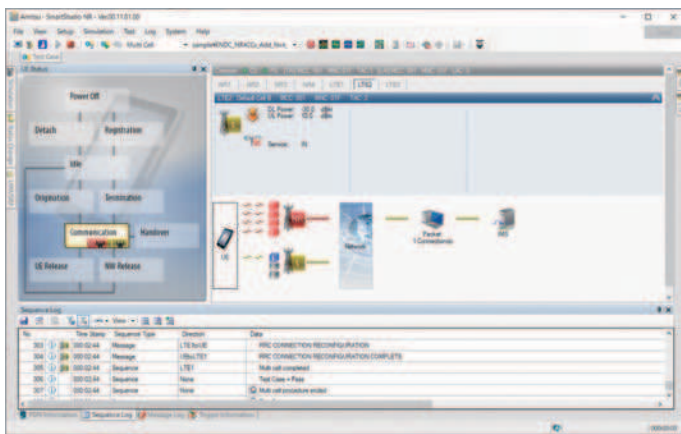

SmartStudio NR Main Screen

### Easy UE Capability Confirmation

UE Capability data are managed automatically and displayed at the UE Capability Information screen for easy confirmation during testing of UE-supported patterns, etc., of combinations of categories, bands, and CAs.

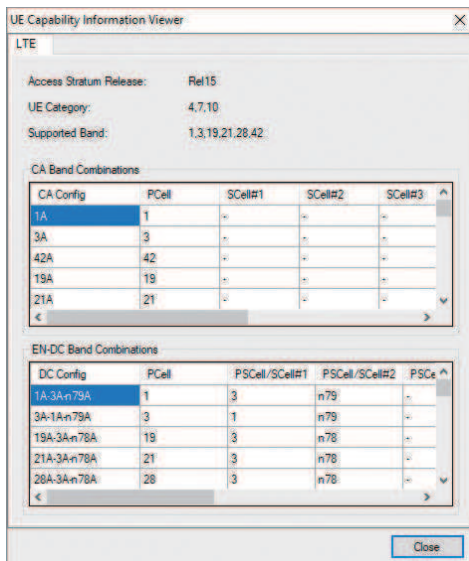

### Test Environment and Base Station Settings

The number of base stations in use, RAT, and antennas are set at the Simulation Parameter screen. In addition, an RF cable setup diagram based on set parameters is displayed, providing strong support for configuring the user's test environment. SIM and other user parameters are also set easily.



Simulation Parameter Settings Screen

Detailed parameters for each base station in use can be set at the Cell Parameter screen, where settings such as the band, frequency, bandwidth, UL/DL power, QAM, MCS, etc., can be set, saved, and loaded.

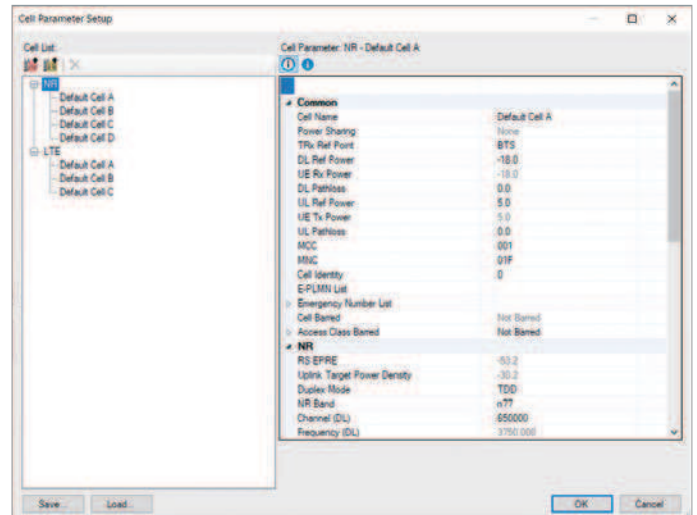

Cell Parameter Settings Screen

The base station TRx power can be changed during the simulation. In addition, base station transmissions can be stopped when executing the out of signal area test, and power can be controlled from the Test Case screen.

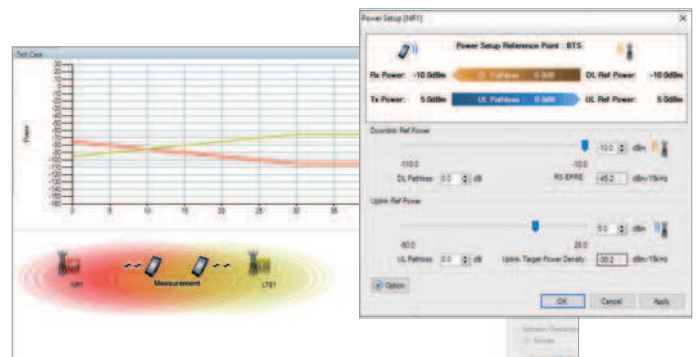

# Radio Communication Test Station MT8000A Features

## Functional and Regression Tests for 5G devices: SmartStudio NR MX800070A

### Built-in IMS/PWS Service

With built-in IMS/PWS Service, the SmartStudio NR MX800070A supports VoLTE and SMS tests without requiring users to configure complex environments. Moreover, PWS Service tests, such as ETWS and CMAS, which are difficult to execute on a live network, are implemented easily, and message contents can also be edited.

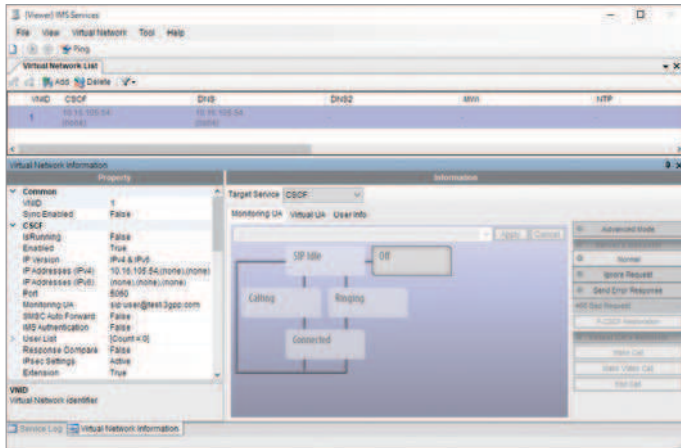

IMS Service Settings Screen

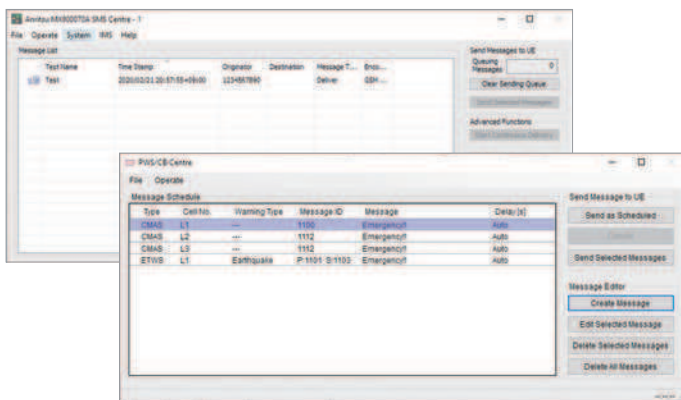

SMS/PWS Service Screen

### Test Automation

Studio NR and the UE can be controlled externally using SmartStudio Manager to configure an automated general test system. In addition to bundled test cases, users can create their own test cases with easy Pass/Fail confirmation after execution.

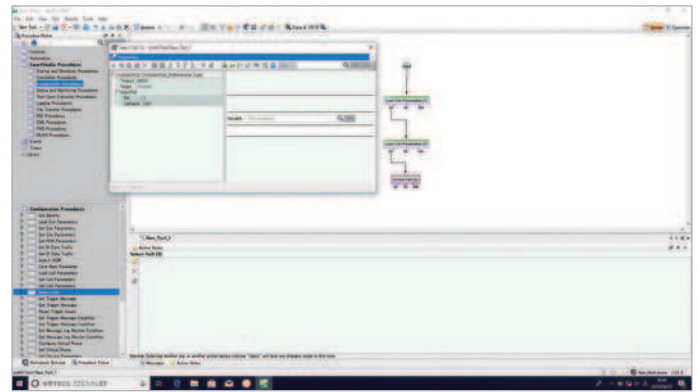

SmartStudio Manager Test Case Creation Screen

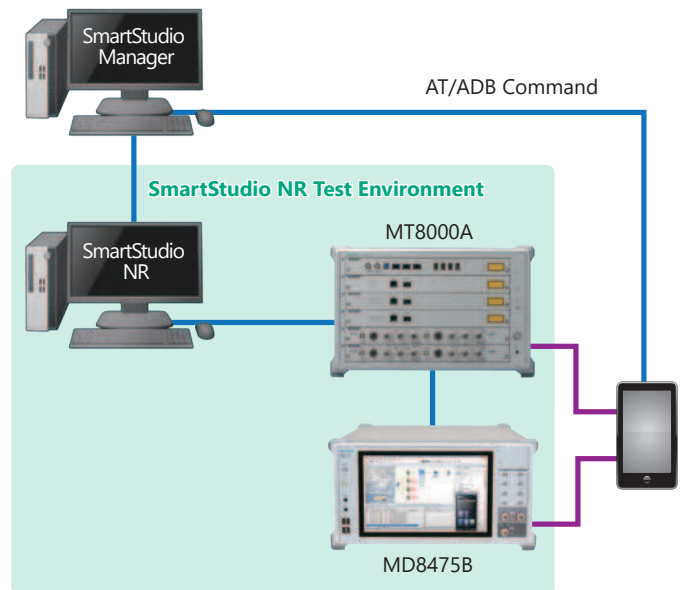

SmartStudio Manager Test Environment Example

# Radio Communication Test Station MT8000A Layout

## MT8000A Front Panel



- 1 Ground Terminal**  
Functional ground terminal used as a measure against electrostatic discharge while using the MT8000A.
- 2 Power Switch**  
Switches power-on and standby. When the MT8000A is in the power on status, the LED lights up (green).
- 3 Standby LED**  
When the MT8000A is in the standby status of which the AC power is on, the LED lights (orange).
- 4 Recover LED/Recover Switch**  
Switch to recover MT8000A in case of emergency. Recovery LED lights up (orange) when the recovery function is enabled.
- 5 Caution LED**  
Lights up (orange) when MT8000A detects abnormality.
- 6 Ready LED**  
Lights up (green) when MT8000A startup is completed after power-on.
- 7 Control Module MT8000A-001 (with Multi-box Data Connection MT8000A-009)**  
Controls the entire MT8000A, processes upper layers, downloads firmware, and start MT8000A. Optical ports are used for connecting multiple MT8000As.
- 8 Data Test Module MT8000A-012**  
Performs data transfer for IP throughput test.
- 9 Baseband Module MT8000A-011**  
Performs baseband processing (L1/L2) in protocol test.
- 10 RF Base Module MT8000A-020 (with MT8000A-022, MT8000A-023)**  
Converts digital signals into analog signals.  
Functions as RF interface for the external RF Converter or for RF signals in 2 GHz to 12 GHz.  
(in 0.4 GHz to 6 GHz when 0.4 GHz-6 GHz RF Sub Module MT8000A-021 is installed)



# Radio Communication Test Station MT8000A Layout

## MT8000A Modules

### Control Module MT8000A-001

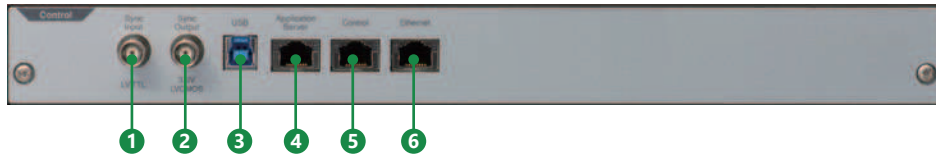

### Control Module MT8000A-001 + Multi-box Data Connection MT8000A-009

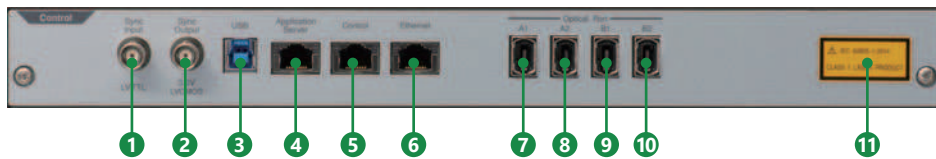

- 1 Sync Input Connector**  
BNC connector for inputting synchronizing signal.
- 2 Sync Output Connector**  
BNC connector for outputting synchronizing signal.
- 3 USB Connector**  
USB (Type B) connector to connect the external PC.
- 4 Application Server Connector**  
RJ-45 connector to connect the external PC for Application Server.
- 5 Control Connector**  
RJ-45 connector for connecting the MT8000A and Control PC.
- 6 Ethernet Connector**  
RJ-45 connector for connecting the external PC, etc.
- 7 Optical Port A1 Connector**  
MPO connector A1 for connecting multiple MT8000As when MT8000A-009 Multi-box Data Connection is installed.
- 8 Optical Port A2 Connector**  
MPO connector A2 for connecting multiple MT8000As when MT8000A-009 Multi-box Data Connection is installed.
- 9 Optical Port B1 Connector**  
MPO connector B1 for connecting multiple MT8000As when MT8000A-009 Multi-box Data Connection is installed.
- 10 Optical Port B2 Connector**  
MPO connector B2 for connecting multiple MT8000As when MT8000A-009 Multi-box Data Connection is installed.
- 11 Explanatory Label**  
Indicates that the Optical Port A1, A2, B1, and B2 are Class 1 laser products.

# Radio Communication Test Station MT8000A Layout

## MT8000A Modules

### Data Test Module MT8000A-012



- 1 Data Test Status LED**  
Indicates the Data Test status.
- 2 Ethernet Connector for Data Test**  
RJ-45 connector for Data Test.
- 3 SFP/SFP+ Connector**  
Connector to insert SFP or SFP+ (application parts) into.
- 4 Explanatory Label**  
Indicates that the device is a Class 1 laser product when SFP or SFP+ are installed.

### Baseband Module MT8000A-011



- 1 Baseband Status LED**  
Indicates the Baseband status.
- 2 Ethernet Connector for Baseband**  
RJ-45 connector for Baseband.
- 3 SFP/SFP+ Connector**  
Connector to insert SFP or SFP+ (application parts) into.
- 4 Explanatory Label**  
Indicates that the device is a Class 1 laser product when SFP or SFP+ are installed.

# Radio Communication Test Station MT8000A Layout

## MT8000A Modules

### RF Base MT8000A-020

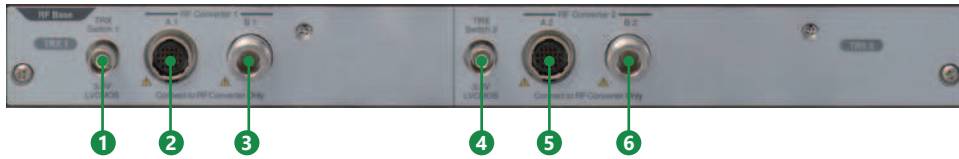

### MT8000A-020 + 3 GHz-12 GHz RF Sub Module MT8000A-022

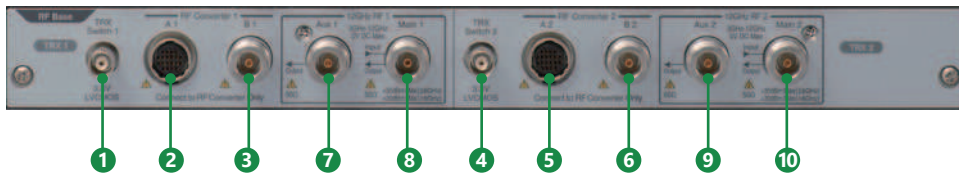

### MT8000A-020 + MT8000A-022 + Extend RF 2.4 GHz-3 GHz MT8000A-023

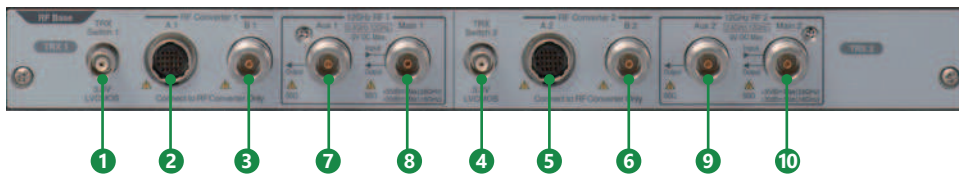

- 1 TRX Switch 1 Connector**  
BNC connector that outputs signals to control the external amplifier, etc.
- 2 RF Converter 1 A1 Connector**  
Multi-contact connector that controls the external RF Converter.
- 3 RF Converter 1 B1 Connector**  
N connector that input/output the external RF Converter and RF signals.
- 4 TRX Switch 2 Connector**  
BNC connector that outputs signals to control the external amplifier, etc.
- 5 RF Converter 2 A2 Connector**  
Multi-contact connector that controls the external RF Converter.
- 6 RF Converter 2 B2 Connector**  
N connector that inputs/outputs the RF signals between the external RF Converter and MT8000A.
- 7 12 GHz RF1 Aux 1 Connector**  
RF auxiliary connector (output) when 3 GHz-12 GHz RF Sub Module option is installed.
- 8 12 GHz RF1 Main 1 Connector**  
RF main connector (input/output) when 3 GHz-12 GHz RF Sub Module option is installed.
- 9 12 GHz RF2 Aux 2 Connector**  
RF auxiliary connector (output) when 3 GHz-12 GHz RF Sub Module option is installed.
- 10 12 GHz RF2 Main 2 Connector**  
RF main connector (input/output) when 3 GHz-12 GHz RF Sub Module option is installed.

Note: The frequency range indicated on the panel is "2.4 GHz-12 GHz" when MT8000A-023 Extend RF 2.4 GHz-3 GHz is installed. RF Converter 1 and RF Converter 2 cannot be used simultaneously with 12 GHz RF 1 and 12 GHz RF 2 respectively.

# Radio Communication Test Station MT8000A Layout

## MT8000A Modules

### RF Base Module MT8000A-020 + 0.4 GHz-6 GHz RF Sub Module MT8000A-021

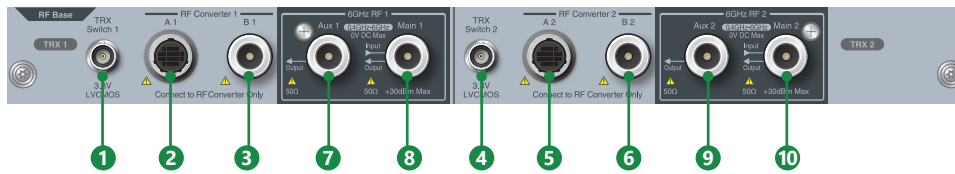

- 1 TRX Switch 1 connector**  
BNC connector that outputs signals to control the external amplifier, etc.
- 2 RF Converter 1 A1 connector**  
Multi-contact connector that controls the external RF Converter.
- 3 RF Converter 1 B1 connector**  
N connector that input/output the external RF Converter and RF signals.
- 4 TRX Switch 2 connector**  
BNC connector that outputs signals to control the external amplifier, etc.
- 5 RF Converter 2 A2 connector**  
Multi-contact connector that controls the external RF Converter.
- 6 RF Converter 2 B2 connector**  
N connector that inputs/outputs the RF signals between the external RF Converter and MT8000A.
- 7 6 GHz RF1 Aux 1 connector**  
RF auxiliary connector (output) when 0.4 GHz-6 GHz RF Sub Module option is installed.
- 8 6 GHz RF1 Main 1 connector**  
RF main connector (input/output) when 0.4 GHz-6 GHz RF Sub Module option is installed.
- 9 6 GHz RF2 Aux 2 connector**  
RF auxiliary connector (output) when 0.4 GHz-6 GHz RF Sub Module option is installed.
- 10 6 GHz RF2 Main 2 connector**  
RF main connector (input/output) when 0.4 GHz-6 GHz RF Sub Module option is installed.

Note: The frequency range indicated on the panel is "0.4 GHz-6 GHz" when 0.4 GHz-6 GHz RF Sub Module MT8000A-021 is installed.  
RF Converter 1 and RF Converter 2 cannot be used simultaneously with 6 GHz RF 1 and 6 GHz RF 2 respectively.



# Radio Communication Test Station MT8000A Layout

## MT8000A Modules

### Multi RF Module MT8000A-031/Multi RF Extension MT8000A-032

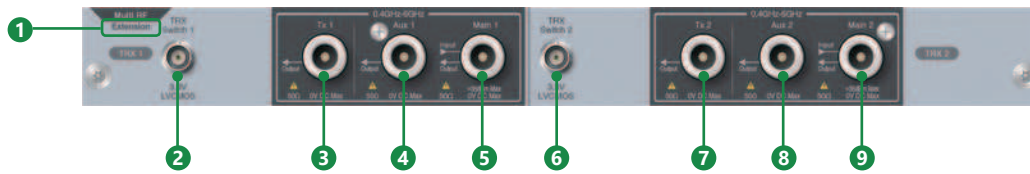

- 1 Extension marking**  
Mark for Multi RF Extension MT8000A-032. No mark for Multi RF Module MT8000A-031.
- 2 TRX Switch 1 connector**  
BNC connector that outputs signals to control the external amplifier, etc.
- 3 Tx 1 connector**  
RF transmission connector (output) for 0.4 GHz-6 GHz signal.
- 4 Aux 1 connector**  
RF auxiliary connector (output) for 0.4 GHz-6 GHz signal.
- 5 Main 1 connector**  
RF main connector (input/output) for 0.4 GHz-6 GHz signal.
- 6 TRX Switch 2 connector**  
BNC connector that outputs signals to control the external amplifier, etc.
- 7 Tx 2 connector**  
RF transmission connector (output) for 0.4 GHz-6 GHz signal.
- 8 Aux 2 connector**  
RF auxiliary connector (output) for 0.4 GHz-6 GHz signal.
- 9 Main 2 connector**  
RF main connector (input/output) for 0.4 GHz-6 GHz signal.

# Radio Communication Test Station MT8000A Layout

## MT8000A Rear Panel

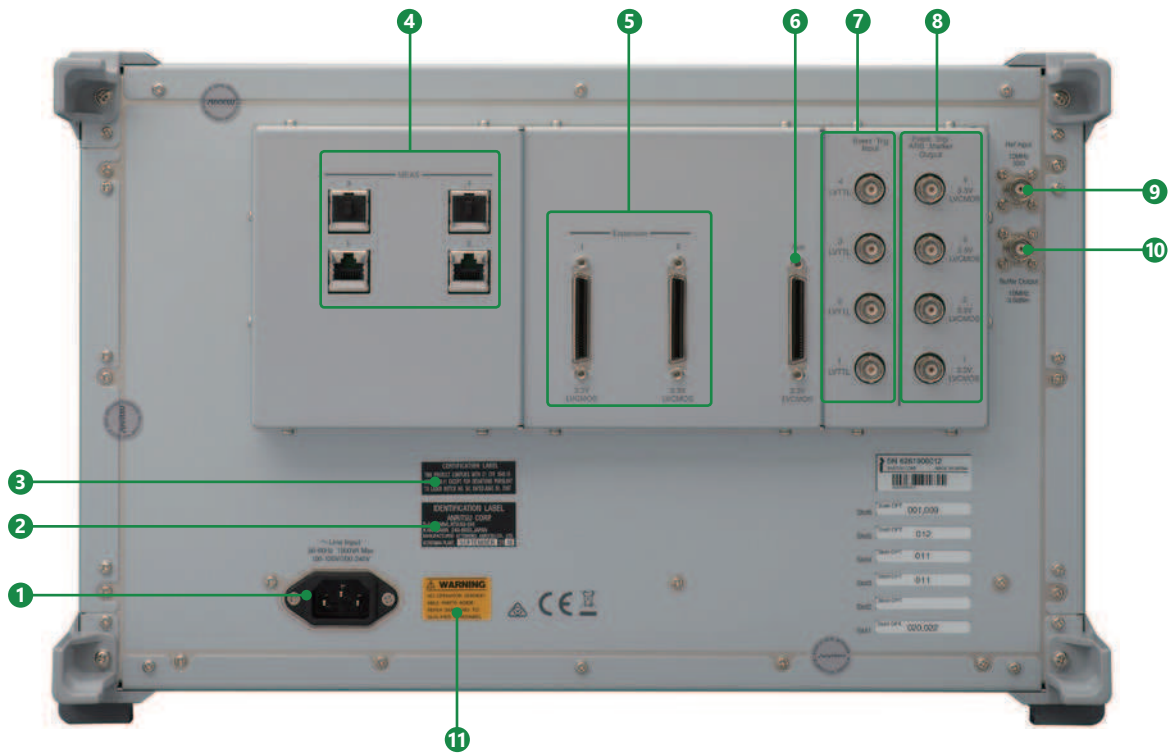

- 1 Power Inlet**  
Power cable connector for 100 V(ac) to 120 V(ac) or 200 V(ac) to 240 V(ac) (50 Hz/60 Hz) (auto-switching).  
Power consumption: 1500 VA or less.
- 2 Identification Label**  
Identifies the manufacturer of laser products.
- 3 Certification Label**  
Certifies that the MT8000A conforms to 21 CFR 1040.10 AND 1040.11 except Laser Notice No.50.
- 4 Ethernet Connector for Measure**  
RJ-45 connector for measurement.
- 5 Expansion Connector**  
Used for input/output of trigger signals.
- 6 Aux Connector**  
Auxiliary connector to output frame timing signals.
- 7 Event Trigger Input Connector**  
BNC connector to input event triggers from external devices. Can input event trigger signals of 4 systems.
- 8 Event Trigger Output Connector**  
BNC connector to output event triggers to external devices. Can output event trigger signals of 4 systems. Can be used also as output of ARB marker.
- 9 Reference signal input connector**  
BNC connector to input 10 MHz reference signal from external devices.
- 10 Reference Signal Output Connector**  
BNC connector to output 10 MHz reference signal built in the MT8000A.
- 11 Safety Label**  
WARNING label for safe operation of MT8000A. Observe the description on the label.

# Radio Communication Test Station MT8000A Layout

## System Configuration



- 1 Radio Communication Test Station MT8000A**  
All-in-one test platform supporting 5G RF measurements and protocol tests.
- 2 28 GHz RF Converter MA80001A/39 GHz RF Converter MA80002A**  
Convert frequency of RF signal output from MT8000A to 28 GHz and 39 GHz band.
- 3 RF Chamber MA8171A**  
For 5G RF measurements/protocol tests in OTA environment.
- 4 Position Controller MA8174A**  
Controls the Positioner MA8175A rotational angle inside the RF Chamber MA8171A.

# Radio Communication Test Station MT8000A Specifications

## Radio Communication Test Station MT8000A

Reference Oscillator	<p>Reference frequency: 10 MHz</p> <p>Start-up characteristics: <math>\pm 5 \times 10^{-8}</math> (3 min. after power-on. Referenced to frequency 1 hour after power-on)</p> <p>Aging rate: <math>\pm 1 \times 10^{-9}</math>/day (referenced to frequency 48-hour after power-on)  <math>\pm 1 \times 10^{-7}</math>/year (referenced to frequency 10-day after power-on)</p> <p>Temperature characteristics: <math>\pm 2 \times 10^{-8}</math></p> <p>Frequency adjusted at shipment: <math>\pm 2.2 \times 10^{-8}</math> (+18°C to +28°C, referenced to frequency 1 hour after power-on)</p> <p>10 MHz Buffer Output          Frequency: 10 MHz          Connector: BNC (f)          Impedance: 50Ω (nom.)          Output Level: <math>\geq 0</math> dBm (AC coupling)</p> <p>10 MHz Ref Input          Frequency: 10 MHz          Operating range: <math>\pm 1</math> ppm          Connector: BNC (f)          Impedance: 50Ω (nom.)          Input level: <math>-15</math> dBm <math>\leq</math> level <math>\leq</math> <math>+20</math> dBm (AC coupling)</p>	
External Interface	<p>MEAS 1 to 4: RJ45, 1000Base-T, for slot 1 to 4</p> <p>Event TRIG Input 1 to 4: BNC (f), LVTTTL</p> <p>Event TRIG/ARB Maker Output 1 to 4: BNC (f), 3.3 V LVCMOS</p> <p>Expansion 1, 2: DX20A (3.3 V LVCMOS)</p> <p>Aux: DX20A (3.3 V LVCMOS)</p>	
Power Supply	<p>Rated voltage: 100 V(ac) to 120 V(ac)/200 V(ac) to 240 V(ac)          (Operating voltage is <math>-15\%/+10\%</math> of rated voltage, however, lower limit is 90 V, upper limit is 250 V)</p> <p>Rated frequency: 50 Hz/60 Hz</p> <p>Power consumption: <math>\leq 1500</math> VA (include all options and modules)</p>	
Dimensions and Mass	<p>Dimensions: 426 (W) <math>\times</math> 265 (H) <math>\times</math> 578 (D) mm (excluding projections)</p> <p>Mass: <math>\leq 50</math> kg (including all options)</p>	
Environmental Conditions	<p>Operating temperature range: <math>+5^{\circ}\text{C}</math> to <math>+40^{\circ}\text{C}</math> (without condensation)</p> <p>Storage temperature: <math>-20^{\circ}\text{C}</math> to <math>+71^{\circ}\text{C}</math> (without condensation)</p>	
CE	EMC	2014/30/EU, EN61326-1, EN61000-3-2
	LVD	2014/35/EU, EN61010-1
	RoHS	2011/65/EU, EN50581
Laser Safety*	IEC 60825-1 Class 1 FDA 21CFR1040.10 and 1040.11 Excludes deviations caused by conformance to LASER Notice No.50 dated June 24, 2007	

\*: Safety measures for laser products

This option complies with optical safety standards in IEC 60825-1, 21CFR1040.10 and 1040.11; the following descriptive labels are affixed to the product.



THIS PRODUCT COMPLIES WITH 21 CFR 1040.10 AND 1040.11 EXCEPT FOR DEVIATIONS PURSUANT TO LASER NOTICE NO. 50, DATED JUNE 24, 2007

## Control Module MT8000A-001

External Interface	<p>USB: USB (Type-B)</p> <p>Application Server: RJ-45 (1000Base-T)</p> <p>Control: RJ-45 (1000Base-T)</p> <p>Ethernet: RJ-45 (1000Base-T)</p> <p>Sync Input: BNC (f) (LVTTTL)</p> <p>Sync Output: BNC (f) (3.3 V LVCMOS)</p>
--------------------	------------------------------------------------------------------------------------------------------------------------------------------------------------------------------------------------------------------------------

## Multi-box Data Connection MT8000A-009

External Interface	Optical Port A1, A2, B1, B2: MPO optical adapter (m), 24 cores
--------------------	----------------------------------------------------------------



# Radio Communication Test Station MT8000A Specifications

## Baseband Module MT8000A-011

External Interface	Ethernet: RJ-45 (1000Base-T) SFP/SFP+: SFF-8431, SFF-8472 compliant IEEE 802.3ae-2002, IEEE 802.3-2008 compliant
--------------------	------------------------------------------------------------------------------------------------------------------------

## Data Test Module MT8000A-012

External Interface	Ethernet: RJ-45, 1000Base-T SFP/SFP+: SFF-8431, SFF-8472 compliant IEEE 802.3ae-2002, IEEE 802.3-2008 compliant
--------------------	-----------------------------------------------------------------------------------------------------------------------

## RF Base Module MT8000A-020

IF Input/Output Connector	RF Converter B1, B2 Connector: N (f) Impedance: 50Ω (nom.)
External Interface	RF Converter A1, A2: Round multiway type connector TRX Switch 1, 2: BNC (f) (3.3 V LVCMOS)

## 0.4 GHz-6 GHz RF Sub Module MT8000A-021

General	<p>RF input/output connector Main 1, Main 2 Connector: N (f) Impedance: 50Ω (nom.) VSWR At 0.4 GHz ≤ setting frequency &lt; 3 GHz ≤1.5 (0.4 GHz ≤ frequency &lt; 3.1 GHz) At 3 GHz ≤ setting frequency ≤ 6 GHz ≤1.5 (2.9 GHz ≤ frequency ≤ 6.1 GHz)</p> <p>RF output connector Aux 1, Aux 2 Connector: N (f) Impedance: 50Ω (nom.) VSWR At 0.4 GHz ≤ setting frequency &lt; 3 GHz ≤1.6 (0.4 GHz ≤ frequency &lt; 3.1 GHz) At 3 GHz ≤ setting frequency ≤ 4.2 GHz ≤1.9 (2.9 GHz ≤ frequency ≤ 4.3 GHz) At 4.2 GHz &lt; setting frequency ≤ 6 GHz ≤2.0 (4.1 GHz &lt; frequency ≤ 6.1 GHz)</p>
---------	---------------------------------------------------------------------------------------------------------------------------------------------------------------------------------------------------------------------------------------------------------------------------------------------------------------------------------------------------------------------------------------------------------------------------------------------------------------------------------------------------------------------------------------------------------------------------------------------------------------------------------------------------------------------

# Radio Communication Test Station MT8000A Specifications

Transmission Characteristics	<p>Frequency          Setting range: 0.4 GHz to 6 GHz          Setting resolution: 1 Hz          Accuracy: Depend on accuracy of reference oscillator</p> <p>Level          Setting range          Main 1, Main 2          -110 to -10 dBm (0.4 GHz ≤ setting frequency ≤ 6 GHz)          Aux 1, Aux 2          -110 to 0 dBm (0.4 GHz ≤ setting frequency ≤ 6 GHz)          Setting resolution: 0.1 dB</p> <p>Accuracy          Main 1, Main 2          After Cal, with CW, 0.4 GHz ≤ setting frequency &lt; 3 GHz, output level ≥ -100 dBm          ±0.7 dB (typ.)          ±1.0 dB (+18°C to +28°C)          ±1.3 dB (+5°C to +40°C)          After Cal, with CW, 3 GHz ≤ setting frequency ≤ 6 GHz, output level ≥ -100 dBm          ±1.0 dB (+18°C to +28°C)          ±1.3 dB (+5°C to +40°C)          Aux 1, Aux 2          After Cal, with CW, 0.4 GHz ≤ setting frequency &lt; 3 GHz, output level ≥ -100 dBm          ±0.7 dB (typ.)          ±1.0 dB (+18°C to +28°C)          ±1.3 dB (+5°C to +40°C)          After Cal, with CW, 3 GHz ≤ setting frequency ≤ 4.2 GHz, output level ≥ -100 dBm          ±1.0 dB (+18°C to +28°C)          ±1.3 dB (+5°C to +40°C)          After Cal, with CW, 4.2 GHz &lt; setting frequency ≤ 6 GHz, output level ≥ -100 dBm          ±1.5 dB (+18°C to +28°C)          ±2.0 dB (+5°C to +40°C)</p> <p>Signal purity          Non-harmonic spurious          With CW, 0.4 GHz ≤ setting frequency &lt; 0.6 GHz, maximum output level,          setting frequency ±10 MHz (exclude &lt;0.4 GHz), exclude setting frequency ±2.5 MHz          ≤-40 dBc          With CW, 0.6 GHz ≤ setting frequency &lt; 3.3 GHz, maximum output level, non-harmonic on setting frequency ±100 MHz,          exclude setting frequency ±2.5 MHz          ≤-40 dBc          With CW, 3.3 GHz ≤ setting frequency ≤ 6 GHz, maximum output level, non-harmonic on setting frequency ±200 MHz,          exclude setting frequency ±2.5 MHz          ≤-40 dBc          With CW, 0.4 GHz ≤ setting frequency &lt; 0.6 GHz, maximum output level,          0.4 GHz ≤ non-harmonic frequency ≤ 6 GHz, exclude setting frequency ±10 MHz          ≤-30 dBc          With CW, 0.6 GHz ≤ setting frequency &lt; 3.3 GHz, maximum output level,          0.4 GHz ≤ non-harmonic frequency ≤ 6 GHz, exclude setting frequency ±100 MHz          ≤-30 dBc          With CW, 3.3 GHz ≤ setting frequency ≤ 6 GHz, maximum output level,          0.4 GHz ≤ non-harmonic frequency ≤ 6.2 GHz, exclude setting frequency ±200 MHz          ≤-30 dBc          Harmonic spurious          With CW, 0.4 GHz ≤ setting frequency ≤ 3 GHz, maximum output level          ≤-25 dBc</p> <p>Maximum modulation bandwidth          20 MHz (0.4 GHz ≤ setting frequency &lt; 0.6 GHz)          200 MHz (0.6 GHz ≤ setting frequency &lt; 3.3 GHz)          400 MHz (3.3 GHz ≤ setting frequency ≤ 6 GHz)</p>
------------------------------	------------------------------------------------------------------------------------------------------------------------------------------------------------------------------------------------------------------------------------------------------------------------------------------------------------------------------------------------------------------------------------------------------------------------------------------------------------------------------------------------------------------------------------------------------------------------------------------------------------------------------------------------------------------------------------------------------------------------------------------------------------------------------------------------------------------------------------------------------------------------------------------------------------------------------------------------------------------------------------------------------------------------------------------------------------------------------------------------------------------------------------------------------------------------------------------------------------------------------------------------------------------------------------------------------------------------------------------------------------------------------------------------------------------------------------------------------------------------------------------------------------------------------------------------------------------------------------------------------------------------------------------------------------------------------------------------------------------------------------------------------------------------------------------------------------------------------------------------------------------------------------------------------------------------------------------------------------------------------------------------------------------------------------------------------------------------------------------------------------------------------------------------------------------------------------------------------------------------------------------------------------------------------------------------------------------------------------------------------------------------------------------------------------------------------------------------------------------------------------------------------------------------------------------------------------------------------------------------------------------------------------------------------------------------------------------------------------------------------------------------------------------------------------------------------------------------------------------------------------------------------------------------------------------------------------------------------------------------------------------------------------------------------------------------------------------------------------------------------------------------------------

# Radio Communication Test Station MT8000A Specifications

Receiving Characteristics	<p>Frequency Setting range: 0.4 GHz to 6 GHz Setting resolution: 1 Hz</p> <p>Level Maximum input level: +30 dBm, 0 VDC (0.4 GHz ≤ setting frequency ≤ 6 GHz, with CW) Setting range: -50 to +26 dBm Setting resolution: 0.1 dB</p> <p>Amplitude Measurement resolution: 0.01 dB Measurement accuracy After Cal, with CW, 0.4 GHz ≤ setting frequency &lt; 3 GHz, measurement bandwidth is 100 MHz, at the signal equal to the setting frequency and the setting level ±0.5 dB (Setting level ≥ -20 dBm, typical) ±0.7 dB (Setting level ≥ -40 dBm, typical) ±1.0 dB (Setting level ≥ -40 dBm, +18°C to +28°C) ±1.3 dB (Setting level ≥ -50 dBm, +18°C to +28°C) After Cal, with CW, 3 GHz ≤ setting frequency ≤ 6 GHz, measurement bandwidth is 100 MHz, at the signal equal to the setting frequency and the setting level ±1.0 dB (Setting level ≥ -40 dBm, +18°C to +28°C) ±1.3 dB (Setting level ≥ -50 dBm, +18°C to +28°C)</p>
---------------------------	-------------------------------------------------------------------------------------------------------------------------------------------------------------------------------------------------------------------------------------------------------------------------------------------------------------------------------------------------------------------------------------------------------------------------------------------------------------------------------------------------------------------------------------------------------------------------------------------------------------------------------------------------------------------------------------------------------------------------------------------------------------------------------------------------------------------------------------------------------------------------------------------------------------------------------------------------------------------------------------------------

### 3 GHz-12 GHz RF Sub Module MT8000A-022

#### Extend RF 2.4 GHz-3 GHz MT8000A-023

#### Extend RF 6 GHz-7.125 GHz MT8000A-024

General	<p>RF input/output connector Main 1, Main 2 Connector: N (f) Impedance: 50Ω (nom.) VSWR At 2.4 GHz ≤ setting frequency &lt; 3 GHz, with MT8000A-023 ≤1.7 (2.3 GHz ≤ frequency &lt; 3.1 GHz) At 3 GHz ≤ setting frequency ≤ 6 GHz ≤1.5 (2.9 GHz ≤ frequency ≤ 6.1 GHz) At 6 GHz &lt; setting frequency ≤ 7.125 GHz, with MT8000A-024 ≤1.7 (5.9 GHz &lt; frequency ≤ 7.225 GHz)</p> <p>RF output connector Aux 1, Aux 2 Connector: N (f) Impedance: 50Ω (nom.) VSWR At 2.4 GHz ≤ setting frequency ≤ 4.2 GHz, with MT8000A-023 ≤1.8 (2.3 GHz ≤ frequency ≤ 4.3 GHz) At 3 GHz ≤ setting frequency ≤ 4.2 GHz, without MT8000A-023 ≤1.8 (2.9 GHz ≤ frequency ≤ 4.3 GHz) At 4.2 GHz &lt; setting frequency ≤ 6 GHz ≤2.0 (4.1 GHz &lt; frequency ≤ 6.1 GHz) At 6 GHz &lt; setting frequency ≤ 7.125 GHz, with MT8000A-024 ≤2.2 (5.9 GHz &lt; frequency ≤ 7.225 GHz)</p>
---------	----------------------------------------------------------------------------------------------------------------------------------------------------------------------------------------------------------------------------------------------------------------------------------------------------------------------------------------------------------------------------------------------------------------------------------------------------------------------------------------------------------------------------------------------------------------------------------------------------------------------------------------------------------------------------------------------------------------------------------------------------------------------------------------------------------------------------------------------------------------------------------------------------------------------------------------------------------

# Radio Communication Test Station MT8000A Specifications

<p>Transmission Characteristics</p>	<p>Frequency            Setting range: 2 GHz to 12 GHz            Setting resolution: 1 Hz            Accuracy: Depend on accuracy of reference oscillator</p> <p>Level            Setting range            Main 1, Main 2            -110 to -10 dBm (2 GHz ≤ setting frequency ≤ 6 GHz)            -110 to -18 dBm (6 GHz &lt; setting frequency ≤ 12 GHz)            Aux 1, Aux 2            -110 to 0 dBm (2 GHz ≤ setting frequency ≤ 6 GHz)            -110 to -8 dBm (6 GHz &lt; setting frequency ≤ 12 GHz)            Setting resolution: 0.1 dB</p> <p>Accuracy            Main 1, Main 2            After Cal, with CW, 2.4 GHz ≤ setting frequency &lt; 3 GHz, output level ≥ -100 dBm, with MT8000A-023              ±0.7 dB (typ.)              ±1.0 dB (+18°C to +28°C)              ±1.3 dB (+5°C to +40°C)            After Cal, with CW, 3 GHz ≤ setting frequency ≤ 6 GHz, output level ≥ -100 dBm              ±1.0 dB (+18°C to +28°C)              ±1.3 dB (+5°C to +40°C)            After Cal, with CW, 6 GHz &lt; setting frequency ≤ 7.125 GHz, output level ≥ -100 dBm, with MT8000A-024              ±1.3 dB (+18°C to +28°C)              ±1.6 dB (+5°C to +40°C)</p> <p>Aux 1, Aux 2            After Cal, with CW, 2.4 GHz ≤ setting frequency &lt; 3 GHz, output level ≥ -100 dBm, with MT8000A-023              ±0.7 dB (typ.)              ±1.0 dB (+18°C to +28°C)              ±1.3 dB (+5°C to +40°C)            After Cal, with CW, 3 GHz ≤ setting frequency ≤ 4.2 GHz, output level ≥ -100 dBm              ±1.0 dB (+18°C to +28°C)              ±1.3 dB (+5°C to +40°C)            After Cal, with CW, 4.2 GHz &lt; setting frequency ≤ 6 GHz, output level ≥ -100 dBm              ±1.5 dB (+18°C to +28°C)              ±2.0 dB (+5°C to +40°C)            After Cal, with CW, 6 GHz &lt; setting frequency ≤ 7.125 GHz, output level ≥ -100 dBm, with MT8000A-024              ±1.5 dB (typ.)              ±1.8 dB (+18°C to +28°C)              ±2.3 dB (+5°C to +40°C)</p> <p>Signal purity            Non-harmonic spurious            With CW, maximum output level, setting frequency ±100 MHz, exclude setting frequency ±2.5 MHz              ≤ -40 dBc (2.4 GHz ≤ setting frequency ≤ 6 GHz, with MT8000A-023)              ≤ -40 dBc (3 GHz ≤ setting frequency ≤ 6 GHz, without MT8000A-023)              ≤ -40 dBc (2.4 GHz ≤ setting frequency ≤ 7.125 GHz, with MT8000A-023 and MT8000A-024)              ≤ -40 dBc (3 GHz ≤ setting frequency ≤ 7.125 GHz, without MT8000A-023, with MT8000A-024)            With CW, maximum output level, exclude setting frequency ±100 MHz              ≤ -30 dBc (2.4 GHz ≤ setting frequency ≤ 6 GHz, 2.3 GHz ≤ non-harmonic frequency ≤ 6.1 GHz, with MT8000A-023)              ≤ -30 dBc (3 GHz ≤ setting frequency ≤ 6 GHz, 2.9 GHz ≤ non-harmonic frequency ≤ 6.1 GHz, without MT8000A-023)              ≤ -30 dBc (2.4 GHz ≤ setting frequency ≤ 7.125 GHz, 2.3 GHz ≤ non-harmonic frequency ≤ 7.225 GHz, with MT8000A-023 and MT8000A-024)              ≤ -30 dBc (3 GHz ≤ setting frequency ≤ 7.125 GHz, 2.9 GHz ≤ non-harmonic frequency ≤ 7.225 GHz, without MT8000A-023, with MT8000A-024)</p> <p>Maximum modulation bandwidth: 200 MHz (2 GHz ≤ setting frequency ≤ 6 GHz)              1 GHz (6 GHz &lt; setting frequency ≤ 12 GHz)</p>
<p>Receiving Characteristics</p>	<p>Frequency            Setting range: 2 GHz to 12 GHz (Center frequency setting range of measurement software)            Setting resolution: 1 Hz</p> <p>Level            Maximum input level: +35 dBm, 0 VDC (2.4 GHz ≤ setting frequency ≤ 6 GHz, with CW, with MT8000A-023)              +35 dBm, 0 VDC (3 GHz ≤ setting frequency ≤ 6 GHz, with CW, without MT8000A-023)              +30 dBm, 0 VDC (6 GHz &lt; setting frequency ≤ 12 GHz, with CW)</p> <p>Setting range: -50 to +26 dBm            Setting resolution: 0.1 dB</p> <p>Amplitude            Measurement resolution: 0.01 dB            Measurement accuracy: At the signal equal to the setting frequency and the setting level            After Cal, with CW, 2.4 GHz ≤ setting frequency &lt; 3 GHz, measurement bandwidth is 100 MHz, with MT8000A-023              ±0.5 dB (Setting level ≥ -20 dBm, typ.)              ±0.7 dB (Setting level ≥ -40 dBm, typ.)              ±1.0 dB (Setting level ≥ -40 dBm, +18°C to +28°C)              ±1.3 dB (Setting level ≥ -50 dBm, +18°C to +28°C)            After Cal, with CW, 3 GHz ≤ setting frequency ≤ 6 GHz, measurement bandwidth is 100 MHz              ±1.0 dB (Setting level ≥ -40 dBm, +18°C to +28°C)              ±1.3 dB (Setting level ≥ -50 dBm, +18°C to +28°C)            After Cal, with CW, 6 GHz &lt; setting frequency ≤ 7.125 GHz, measurement bandwidth is 100 MHz, with MT8000A-024              ±1.3 dB (Setting level ≥ -40 dBm, +18°C to +28°C)              ±1.6 dB (Setting level ≥ -50 dBm, +18°C to +28°C)</p>

# Radio Communication Test Station MT8000A Specifications

## 0.4 GHz-6 GHz Multi RF Module MT8000A-031, 0.4 GHz-6 GHz Multi RF Extension MT8000A-032

General	<p>RF input/output connector Main 1, Main 2 Connector: N (f) Impedance: 50Ω (nom.) VSWR: <math>\leq 1.5</math> (0.4 GHz <math>\leq</math> frequency <math>\leq</math> 6 GHz)</p> <p>RF output connector Aux 1, Aux 2, Tx 1, Tx 2 Connector: N (f) Impedance: 50Ω (nom.) VSWR: <math>\leq 1.6</math> (0.4 GHz <math>\leq</math> frequency <math>\leq</math> 3.1 GHz) <math>\leq 1.9</math> (3.1 GHz &lt; frequency <math>\leq</math> 4.3 GHz) <math>\leq 2.0</math> (4.3 GHz &lt; frequency <math>\leq</math> 6.0 GHz)</p>
Transmission Characteristics	<p>Frequency Setting range: 0.4 GHz to 6.0 GHz (Frequency setting range of measurement software) Setting resolution: 1 Hz Accuracy: Depend on accuracy of reference oscillator</p> <p>Level Setting range Main 1, Main 2 <math>-110</math> to <math>-10</math> dBm (0.4 GHz <math>\leq</math> setting frequency <math>\leq</math> 6 GHz) Aux 1, Aux 2, Tx 1, Tx 2 <math>-110</math> to 0 dBm (0.4 GHz <math>\leq</math> setting frequency <math>\leq</math> 6 GHz) Setting resolution: 0.1 dB</p> <p>Accuracy Main 1, Main 2 After Cal, with CW, 0.4 GHz <math>\leq</math> setting frequency &lt; 3 GHz, Setting level <math>\geq -100</math> dBm <math>\pm 0.7</math> dB (Typ.) <math>\pm 1.0</math> dB (+18°C to +28°C) <math>\pm 1.3</math> dB (+5°C to +40°C) After Cal, with CW, 3 GHz <math>\leq</math> setting frequency <math>\leq</math> 6 GHz, Setting level <math>\geq -100</math> dBm <math>\pm 1.0</math> dB (+18°C to +28°C) <math>\pm 1.3</math> dB (+5°C to +40°C) Aux 1, Aux 2, Tx 1, Tx 2 After Cal, with CW, 0.4 GHz <math>\leq</math> setting frequency &lt; 3 GHz, Setting level <math>\geq -100</math> dBm <math>\pm 0.7</math> dB (Typ.) <math>\pm 1.0</math> dB (+18°C to +28°C) <math>\pm 1.3</math> dB (+5°C to +40°C) After Cal, with CW, 3 GHz <math>\leq</math> setting frequency <math>\leq</math> 4.2 GHz, Setting level <math>\geq -100</math> dBm <math>\pm 1.0</math> dB (+18°C to +28°C) <math>\pm 1.3</math> dB (+5°C to +40°C) After Cal, with CW, 4.2 GHz &lt; setting frequency <math>\leq</math> 6 GHz, Setting level <math>\geq -100</math> dBm <math>\pm 1.5</math> dB (+18°C to +28°C) <math>\pm 2.0</math> dB (+5°C to +40°C)</p> <p>Signal purity Non-harmonic spurious: With CW, maximum out level <math>\leq -40</math> dBc (0.4 GHz <math>\leq</math> setting frequency &lt; 0.6 GHz, non-harmonic spurious within setting frequency <math>\pm 10</math> MHz, exclude setting frequency &lt; 0.4 GHz, exclude non-harmonic spurious within setting frequency <math>\pm 2.5</math> MHz) <math>\leq -40</math> dBc (0.6 GHz <math>\leq</math> setting frequency <math>\leq</math> 6 GHz, non-harmonic spurious within setting frequency <math>\pm 100</math> MHz, exclude non-harmonic spurious within setting frequency <math>\pm 2.5</math> MHz) <math>\leq -30</math> dBc (0.4 GHz <math>\leq</math> setting frequency &lt; 0.6 GHz, 0.4 GHz <math>\leq</math> non-harmonic spurious <math>\leq</math> 6 GHz, exclude non-harmonic spurious within setting frequency <math>\pm 10</math> MHz) <math>\leq -30</math> dBc (0.6 GHz <math>\leq</math> setting frequency &lt; 3.3 GHz, 0.4 GHz <math>\leq</math> non-harmonic spurious <math>\leq</math> 6 GHz, exclude non-harmonic spurious within setting frequency <math>\pm 100</math> MHz) <math>\leq -30</math> dBc (3.3 GHz <math>\leq</math> setting frequency <math>\leq</math> 6 GHz, 0.4 GHz <math>\leq</math> non-harmonic spurious <math>\leq</math> 6.1 GHz, exclude non-harmonic spurious within setting frequency <math>\pm 100</math> MHz) Harmonic spurious: With CW, maximum out level <math>\leq -25</math> dBc (0.4 GHz <math>\leq</math> setting frequency <math>\leq</math> 3 GHz)</p> <p>Maximum modulation bandwidth 20 MHz (0.4 GHz <math>\leq</math> setting frequency &lt; 0.6 GHz) 200 MHz (0.6 GHz <math>\leq</math> setting frequency <math>\leq</math> 6 GHz)</p>
Receiving Characteristics	<p>Frequency Setting range: 0.4 GHz to 6 GHz (Frequency setting range of measurement software) Setting resolution: 1 Hz</p> <p>Level Maximum input level: +35 dBm, 0 VDC (with CW, 0.4 GHz <math>\leq</math> setting frequency <math>\leq</math> 6 GHz) Setting range: <math>-50</math> to +26 dBm Setting resolution: 0.1 dB</p> <p>Amplitude Measurement resolution: 0.01 dB Measurement accuracy: After Cal, with CW, at the signal equal to the setting frequency and the setting level 0.4 GHz <math>\leq</math> setting frequency <math>\leq</math> 0.6 GHz, measurement bandwidth 10 MHz <math>\pm 0.5</math> dB (setting level <math>\geq -20</math> dBm, typ.) <math>\pm 0.7</math> dB (setting level <math>\geq -40</math> dBm, typ.) <math>\pm 1.0</math> dB (setting level <math>\geq -40</math> dBm, +18°C to +28°C) <math>\pm 1.3</math> dB (setting level <math>\geq -50</math> dBm, +18°C to +28°C) 0.6 GHz &lt; setting frequency &lt; 3 GHz, measurement bandwidth 100 MHz <math>\pm 0.5</math> dB (setting level <math>\geq -20</math> dBm, typ.) <math>\pm 0.7</math> dB (setting level <math>\geq -40</math> dBm, typ.) <math>\pm 1.0</math> dB (setting level <math>\geq -40</math> dBm, +18°C to +28°C) <math>\pm 1.3</math> dB (setting level <math>\geq -50</math> dBm, +18°C to +28°C) 3 GHz <math>\leq</math> setting frequency <math>\leq</math> 6 GHz, measurement bandwidth 100 MHz <math>\pm 1.0</math> dB (setting level <math>\geq -40</math> dBm, +18°C to +28°C) <math>\pm 1.3</math> dB (setting level <math>\geq -50</math> dBm, +18°C to +28°C)</p>



# Radio Communication Test Station MT8000A Specifications

## Peripherals

### 28 GHz RF Converter MA80001A

RF Input/Output Connector	Port 1, Port 2 Connector: K (m) Impedance: 50Ω (nom.) VSWR (when transmitted): $\leq 2.5$ (23.75 GHz $\leq$ frequency $\leq$ 30 GHz) VSWR (when received): $\leq 2.5$ (23.45 GHz $\leq$ frequency $\leq$ 30.3 GHz)	
Transmission Characteristics	Frequency Setting range: 24.25 GHz to 29.5 GHz (Center frequency setting range of measurement software) Setting resolution: 1 Hz Accuracy: Depend on accuracy of MT8000A reference oscillator Level Setting range: -90 to +5 dBm Setting resolution: 0.1 dB Accuracy: $\pm 1.5$ dB (+18°C to +28°C, after Cal, with CW) Signal purity Non-harmonic spurious With CW, maximum output level $\leq -40$ dBc (non-harmonic on setting frequency $\pm 500$ MHz, non-harmonic, exclude setting frequency $\pm 50$ MHz) $\leq -30$ dBc (23.75 GHz $\leq$ non-harmonic frequency $\leq$ 30 GHz, exclude setting frequency within $\pm 500$ MHz and -4500 MHz) Maximum modulation bandwidth: 1 GHz	
Receiving Characteristics	Frequency Setting range: 24.25 GHz to 29.5 GHz (Center frequency setting range of measurement software) Setting resolution: 1 Hz Level Maximum input level: +20 dBm, 0 VDC (with CW) Setting range: -70 to +5 dBm Setting resolution: 0.1 dB Amplitude Measurement resolution: 0.01 dB Measurement accuracy: At the signal equal to the setting frequency and the setting level After Cal, with CW, 24.25 GHz $\leq$ setting frequency $\leq$ 29.5 GHz, measurement bandwidth 100 MHz, +18°C to +28°C $\pm 1.5$ dB (-50 dBm $\leq$ setting level $\leq$ +5 dBm) $\pm 2.5$ dB (-70 dBm $\leq$ setting level $<$ -50 dBm)	
IF Input/Output Connector	Connect to MT8000A: B Connector: N (f) Impedance: 50Ω (nom.)	
External Control Connector	Round multiway type connector	
DC Input Connector	Voltage: 12 VDC Current: $\leq 3$ A	
Dimensions and Mass	Dimensions: 92 (W) $\times$ 175 (H) $\times$ 260 (D) mm (excluding projections) Mass: $\leq 6$ kg	
Environmental Conditions	Operating temperature range: +5°C to +40°C (without condensation) Storage temperature range: -20°C to +71°C (without condensation)	
CE	EMC	2014/30/EU, EN61326-1, EN61000-3-2
	LVD	2014/35/EU, EN61010-1
	RoHS	2011/65/EU, EN50581

# Radio Communication Test Station MT8000A Specifications

## Peripherals

### 39 GHz RF Converter MA80002A

RF Input/Output Connector	Port 1, Port 2 Connector: K (m) Impedance: 50Ω (nom.) VSWR: ≤2.9 (36.2 GHz ≤ frequency ≤ 40.0 GHz)	
Transmission Characteristics	Frequency Setting range: 37.0 GHz to 42.5 GHz (Center frequency setting range of measurement software) Setting resolution: 1 Hz Accuracy: Depend on accuracy of MT8000A reference oscillator Level Setting range: -90 to +5 dBm Setting resolution: 0.1 dB Accuracy: ±1.5 dB (typ., after Cal, with CW, 37.0 GHz ≤ setting frequency ≤ 40.0 GHz) ±2.0 dB (+18°C to +28°C, after Cal, with CW, 37.0 GHz ≤ setting frequency ≤ 40.0 GHz) Signal purity Non-harmonic spurious With CW, maximum output level, 37.0 GHz ≤ setting frequency ≤ 40.0 GHz ≤-40 dBc (non-harmonic on setting frequency ±500 MHz, exclude non-harmonic frequency >40.0 GHz and setting frequency ±50 MHz) ≤-30 dBc (36.5 GHz ≤ non-harmonic frequency ≤ 40.0 GHz, exclude setting frequency ±500 MHz) Maximum modulation bandwidth: 1 GHz	
Receiving Characteristics	Frequency Setting range: 37.0 GHz to 42.5 GHz (Center frequency setting range of measurement software) Setting resolution: 1 Hz Level Maximum input level: +17 dBm, 0 VDC (with CW) Setting range: -70 to +5 dBm Setting resolution: 0.1 dB Amplitude Measurement resolution: 0.01 dB Measurement accuracy: At the signal equal to the setting frequency and the setting level After Cal, with CW, 37.0 GHz ≤ setting frequency ≤ 40.0 GHz, measurement bandwidth 100 MHz ±1.5 dB (-50 dBm ≤ setting level ≤ +5 dBm, typ.) ±2.0 dB (-70 dBm ≤ setting level < -50 dBm, typ.) ±2.0 dB (-50 dBm ≤ setting level ≤ +5 dBm, +18°C to +28°C) ±2.5 dB (-70 dBm ≤ setting level < -50 dBm, +18°C to +28°C)	
IF Input/Output Connector	Connect to MT8000A: B Connector: N (f) Impedance: 50Ω (nom.)	
External Control Connector	Round multiway type connector	
DC Input Connector	Voltage: 12 VDC Current: ≤4 A	
Dimensions and Mass	Dimensions: 92 (W) × 175 (H) × 304 (D) mm (excluding projections) Mass: ≤6 kg	
Environmental Conditions	Operating temperature range: +5°C to +40°C (without condensation) Storage temperature: -20°C to +71°C (without condensation)	
CE	EMC	2014/30/EU, EN61326-1, EN61000-3-2
	LVD	2014/35/EU, EN61010-1
	RoHS	2011/65/EU, EN50581

# Radio Communication Test Station MT8000A Specifications

## Peripherals

### Multiband RF Converter MA80003A

RF Input/Output Connector	Port 1, Port 2 Connector: V (m) Impedance: 50Ω (nom.) VSWR: ≤2.5 (22.65 GHz ≤ frequency ≤ 31.1 GHz) ≤2.9 (35.4 GHz ≤ frequency ≤ 43.5 GHz) ≤2.9 (43.5 GHz < frequency ≤ 45.1 GHz, typ.)	
Transmission Characteristics	Frequency Setting range: 24.25 GHz to 29.5 GHz, 37.0 GHz to 43.5 GHz Setting resolution: 1 Hz Accuracy: Depend on accuracy of MT8000A reference oscillator Level Setting range: -70 to +15 dBm Setting resolution: 0.1 dB Accuracy: After Cal, with CW, Setting level ≤ ±10 dBm ±1.5 dB (24.25 GHz ≤ setting frequency ≤ 29.5 GHz, +18°C to +28°C) ±1.5 dB (37.0 GHz ≤ setting frequency ≤ 40.0 GHz, typ.) ±2.0 dB (37.0 GHz ≤ setting frequency ≤ 40.0 GHz, +18°C to +28°C) ±1.5 dB (40.0 GHz < setting frequency ≤ 43.5 GHz, typ.) ±2.0 dB (40.0 GHz < setting frequency ≤ 43.5 GHz, +18°C to +28°C) Signal purity Non-harmonic spurious: With CW, Setting level = +10 dBm In-band Specification: ≤-40 dBc (non-harmonic on setting frequency ±500 MHz, exclude setting frequency ±50 MHz and non-harmonic frequency < 24.25 GHz, 29.5 GHz < non-harmonic frequency < 37.0 GHz and non-harmonic frequency > 43.5 GHz) Specification for interference signal source: ≤-37 dBc (non-harmonic on setting frequency ±1.5 GHz, exclude setting frequency ±500 MHz and non-harmonic frequency < 24.25 GHz, 29.5 GHz < non-harmonic frequency < 37.0 GHz and non-harmonic frequency > 43.5 GHz) Out-of-band Specification: ≤-30 dBc (24.25 GHz ≤ setting frequency ≤ 29.5 GHz, 24.25 GHz ≤ non-harmonic frequency ≤ 29.5 GHz and 37.0 GHz ≤ non-harmonic frequency ≤ 43.5 GHz, exclude setting frequency ±1.5 GHz, setting frequency - 4.5 GHz ±10 MHz and setting frequency + 4.5 GHz ±10 MHz) ≤-30 dBc (37.0 GHz ≤ setting frequency ≤ 43.5 GHz, 24.25 GHz ≤ non-harmonic frequency ≤ 29.5 GHz and 37.0 GHz ≤ non-harmonic frequency ≤ 43.5 GHz, exclude setting frequency ±1.5 GHz) Maximum modulation bandwidth: 1 GHz	
Receiving Characteristics	Frequency Setting range: 24.25 GHz to 29.5 GHz, 37.0 GHz to 43.5 GHz Setting resolution: 1 Hz Level Maximum input level: +20 dBm, 0 VDC (with CW) Setting range: -70 to +10 dBm Setting resolution: 0.1 dB Amplitude Measurement resolution: 0.01 dB Measurement accuracy: After Cal, with CW, measurement bandwidth 100 MHz, at the signal equal to the setting frequency and the setting level 24.25 GHz ≤ setting frequency ≤ 29.5 GHz ±1.0 dB (-50 dBm ≤ setting level ≤ +10 dBm, typ.) ±2.0 dB (-70 dBm ≤ setting level < -50 dBm, typ.) ±1.5 dB (-50 dBm ≤ setting level ≤ +10 dBm, +18°C to +28°C) ±2.5 dB (-70 dBm ≤ setting level < -50 dBm, +18°C to +28°C) 37.0 GHz ≤ setting frequency ≤ 40.0 GHz ±1.5 dB (-50 dBm ≤ setting level ≤ +10 dBm, typ.) ±2.0 dB (-70 dBm ≤ setting level < -50 dBm, typ.) ±2.0 dB (-50 dBm ≤ setting level ≤ +10 dBm, +18°C to +28°C) ±2.5 dB (-70 dBm ≤ setting level < -50 dBm, +18°C to +28°C) 40.0 GHz ≤ setting frequency ≤ 43.5 GHz ±1.5 dB (-50 dBm ≤ setting level ≤ +10 dBm, typ.) ±2.0 dB (-65 dBm ≤ setting level < -50 dBm, typ.) ±2.0 dB (-50 dBm ≤ setting level ≤ +10 dBm, +18°C to +28°C) ±2.5 dB (-65 dBm ≤ setting level < -50 dBm, +18°C to +28°C)	
IF Input/Output Connector	Connector: N (f) Impedance: 50Ω (nom.)	
External Control Connector	Round multiway type connector	
DC Input Connector	Voltage: 18 VDC Current: ≤5.5 A	
Dimensions and Mass	Dimensions: 83 (W) × 175 (H) × 304 (D) mm (excluding projections) Mass: ≤6 kg	
Environmental Conditions	Operating temperature range: +5°C to +45°C (without condensation) Storage temperature range: -20°C to +71°C (without condensation)	
CE	EMC	2014/30/EU, EN61326-1, EN61000-3-2
	LVD	2014/35/EU, EN61010-1
	RoHS	2011/65/EU, EN50581

See **OTA Product Catalog** for detailed information of Shield Box MA8161A, RF Chamber MA8171A and CATR Anechoic chamber MA8172A.

# Radio Communication Test Station MT8000A Ordering Information

Please specify the model/order number, name and quantity when ordering.

The names listed in the chart below are Order Names. The actual name of the item may differ from the Order Name.

Model/Order No.	Name	Model/Order No.	Name
MT8000A	<b>Main Frame</b> Radio Communication Test Station		
J1211	<b>Standard Accessories</b> Power Cord (3.0 m, 100 V, 3 core) :	MX800010A	<b>Software Options</b> NR TDD Measurement Software
J1440A	LAN Cable :	MX800010A-001	NR TDD SA Call Processing Software
W3955AE	MT8000A Operation Manual (DVD) :	MX800010A-002	NR TDD OTA Measurement Software
MX800000A	Platform Software	MX800010A-003	NR IP Data Transfer
		MX800010A-007	NR TDD Sub-6 GHz Measurement
		MX800010A-008	NR TDD mmWave Measurement
		MX800010A-009	NR FDD Measurement
MT8000A-001	<b>Options</b> Control Module	MX800010A-024	NR BW 200 MHz Per Cell
MT8000A-009	Multi-box Data Connection	MX800010A-031	NR TDD DL 2x2 MIMO Up To Total BW 100 MHz
MT8000A-011	Baseband Module	MX800010A-032	NR TDD DL 2x2 MIMO Up To Total BW 200 MHz
MT8000A-012	Data Test Module	MX800010A-033	NR TDD DL 2x2 MIMO Up To Total BW 400 MHz
MT8000A-020	RF Base Module	MX800010A-034	NR TDD DL 2x2 MIMO Up To Total BW 600 MHz
MT8000A-021	0.4 GHz-6 GHz RF Sub Module	MX800010A-035	NR TDD DL 2x2 MIMO Up To Total BW 800 MHz
MT8000A-022	3 GHz-12 GHz RF Sub Module	MX800010A-036	NR TDD DL 4x4 MIMO Up To Total BW 100 MHz
MT8000A-023	Extend RF 2.4 GHz-3 GHz	MX800010A-037	NR TDD DL 4x4 MIMO Up To Total BW 200 MHz
MT8000A-024	Extend RF 6 GHz-7.125 GHz	MX800010A-041	NR TDD DL 2CA For Rx Measurement
MT8000A-031	0.4 GHz-6 GHz Multi RF Module	MX800010A-042	NR TDD DL 3CA For Rx Measurement
MT8000A-032	0.4 GHz-6 GHz Multi RF Extension	MX800010A-043	NR TDD DL 4CA For Rx Measurement
		MX800010A-044	NR TDD DL 5CA For Rx Measurement
MA80001A	<b>Converter</b> 28 GHz RF Converter	MX800010A-045	NR TDD DL 6CA For Rx Measurement
MA80002A	39 GHz RF Converter	MX800010A-046	NR TDD DL 7CA For Rx Measurement
MA80003A	Multiband RF Converter	MX800010A-047	NR TDD DL 8CA For Rx Measurement
J1771A	Coaxial Cord (N-N, 1.0 m)	MX800010A-051	NR TDD UL 2x2 MIMO Up To Total BW 100 MHz
J1771B	Coaxial Cord (N-N, 3.0 m)	MX800010A-061	NR TDD UL 2CA For Tx Measurement
J1772A	Control Cable, 1.0 m	MX800010A-062	NR TDD UL 3CA For Tx Measurement
J1772B	Control Cable, 3.0 m	MX800010A-063	NR TDD UL 4CA For Tx Measurement
		MX800030A	NR Protocol Platform Software
ML2437A	<b>Correction Equipments for OTA Measurement</b> Power Meter	MX800030A-001	NR TDD Platform
MA2444D	Power Sensor	MX800030A-002	NR FDD Platform
MA2445D	Power Sensor	MX800030A-003	Ciphering
41KC-10	10 dB Attenuator	MX800030A-005	5G SA Protocol
J0004	COAXIAL ADAPTOR	MX800030A-006	NR SDAP
J0008	GPIB CABLE, 2.0M	MX800030A-007	NR FDD/TDD Joint CA
K222B	Adaptor	MX800030A-010	RF/Fading Driver For Multiple box
Z1974A	Reference Antenna	MX800030A-031	NR DL 2x2 MIMO BW 50 MHz Per Cell
		MX800030A-032	NR DL 2x2 MIMO BW 100 MHz Per Cell
		MX800030A-033	NR DL 2x2 MIMO BW 200 MHz Per Cell
MT8821C	<b>Measurement Hardware for NSA</b> Radio Communication Analyzer	MX800030A-035	NR DL 4x4 MIMO BW 50 MHz Per Cell
MT8821C-008	LTE Measurement Hardware	MX800030A-036	NR DL 4x4 MIMO BW 100 MHz Per Cell
MX882112C	LTE FDD Measurement Software	MX800030A-041	NR UL 2x2 MIMO BW 50 MHz Per Cell
MX882112C-010	LTE FDD NSA for 5G Anchor	MX800030A-042	NR UL 2x2 MIMO BW 100 MHz Per Cell
MX882113C	LTE TDD Measurement Software	MX800030A-051	NR DL 2CA For Protocol
MX882113C-010	LTE TDD NSA for 5G Anchor	MX800030A-052	NR DL 3CA For Protocol
J1802A	Sync Cable	MX800030A-053	NR DL 4CA For Protocol
MD8430A	Signalling Tester	MX800030A-054	NR DL 5CA For Protocol
MD8430A-005	Extended Frequency Range to 3.8 GHz Hardware2	MX800030A-055	NR DL 6CA For Protocol
MD8430A-035	LTE Enhanced Test Mode I(ETM)	MX800030A-056	NR DL 7CA For Protocol
MD8430A-060	LTE FDD Option	MX800030A-057	NR DL 8CA For Protocol
MD8430A-061	LTE TDD Option	MX800030A-061	NR UL 2CA For Protocol
MD8430A-064	LTE Anchor For 5G NSA Option	MX800030A-062	NR UL 3CA For Protocol
MD8430A-086	Ciphering Option	MX800030A-063	NR UL 4CA For Protocol
MD8430A-SS135	1 Year Support Service for LTE FDD (ETM)	MX800030A-071	Digital IQ Basic For Protocol
MD8430A-SS136	1 Year Support Service for LTE TDD (ETM)	MX800031A	NR Fading Basic
		MX800031A-001	NR Fading 2x2 MIMO
Z2017B	<b>Application Parts</b> Standard PC	MX800031A-002	NR Fading 4x2/4x4 MIMO
Z2035A	Standard PC for SSNR (with monitor)	MX800031A-003	NR Fading 2CA-4CA
Z1320E	Standard PC for RTD (with monitor)	MX800031A-004	NR Fading 5CA-8CA
MT8000A-AK001	Fading Control PC	MX800032A	LTE Protocol Platform Software
MT8000A-AK002	IP Test Server PC	MX800032A-001	LTE Anchor For Protocol
Z1591A	USB Dongle (Protocol)	MX800032A-002	LTE Advance Features
Z2023A	USB Dongle (SmartStudio NR)	MX800050A	Rapid Test Designer Platform (RTD)
G0408A	10 Gig Ethernet SR 850 nm SFP+	MX800050A-001	5G NSA Framework For RTD
J1581A	Optical cable MM LC/PC to LC/PC 3 meter	MX800050A-002	RTD LL/L3 Procedure Libraries (5G)
Z1993A	Optical Connector Cleaner (MPO)	MX800050A-003	Core LTE Framework For RTD
J0127A	COAXIAL CORD, 1.0M	MX800050A-004	UTRAN/GERAN Framework For RTD
J1398A	N-SMA ADAPTOR	MX800050A-005	IMS Framework For RTD
J1440A	LAN Cable	MX800050A-006	IoT Framework For RTD
J1773A	AUX Conversion Adapter	MX800050A-007	LTE-A Framework For RTD
J1798A	GPIB-USB-HS+	MX800050A-008	LTE-A Pro Framework For RTD
Z2032A	Reference Antenna	MX800050A-009	LTE MIMO Framework For RTD

## Radio Communication Test Station MT8000A Ordering Information

Model/Order No.	Name
MX800050A-010	LTE Unlicensed Framework For RTD
MX800050A-011	LTE/UTRAN/GERAN Fading Library For RTD
MX800050A-012	5G Fading Library
MX800050A-013	5G SA Framework For RTD
MX800050A-014	eMBMS Framework For RTD
MX800050A-040	RTD Test Creation and Editing Tools
MX800050A-041	RTD Test Execution Tools
MX800050A-042	RTD Protocol Analyzer
MX800050A-051	RTD Floating (Server Based) License
MX800060A	Control Software
MX800060A-001	NSA Framework For L1/L2 Testing
MX800060A-013	SA Framework For L1/L2 Testing
MX800070A	SmartStudio NR
MX800070A-001	5G NSA Option
MX800070A-003	LTE Core Option
MX800070A-011	NR TDD Option
MX800070A-012	NR FDD Option
MX800070A-030	NR DL 2x2 MIMO BW 100 MHz Per Cell
MX800070A-035	NR DL 4x4 MIMO BW 100 MHz Per Cell
MX800070A-050	NR DL 2CA Option
MX800070A-051	NR DL 3CA Option
MX800070A-052	NR DL 4CA Option
MX800070A-080	IMS Server Option
MX800070A-082	RTP Control Option
MX800079A	NR Platform Software for SmartStudio
	<b>Support Services</b>
MX800010A-SS101	5G NR RF Measurement Support Service (Per Year)
MX800010A-SS102	5G NR RF OTA Measurement Support Service (Per Year)
MX800050A-SS100	RTD Support Service (Per Year)
MX800050A-SS101	5G NSA Support Service (Per Year)
MX800050A-SS103	LTE Support Service (Per Year)
MX800050A-SS104	UTRAN/GERAN Support Service (Per Year)
MX800050A-SS105	IMS Support Service (Per Year)
MX800050A-SS106	IoT Support Service (Per Year)
MX800050A-SS107	LTE-A Support Service (Per Year)
MX800050A-SS108	LTE-A Pro Support Service (Per Year)
MX800050A-SS109	MIMO Support Service (Per Year)
MX800050A-SS110	LTE Unlicensed Support Service (Per Year)
MX800050A-SS111	LTE/UTRAN/GERAN Fading Support Service (Per Year)
MX800050A-SS112	5G Fading Support Service
MX800050A-SS113	5G SA Support Service (Per Year)
MX800050A-SS114	eMBMS Support Service (Per Year)
MX800060A-SS100	Control Software Support Service (Per Year)
MX800060A-SS101	NSA Framework Support Service (Per Year)
MX800060A-SS113	SA Framework Support Service (Per Year)
MX800070A-SS110	SmartStudio Support Service (Per Year)
	<b>Warranty Services</b>
MT8000A-ES210	2 Years Extended Warranty Service
MT8000A-ES310	3 Years Extended Warranty Service
MT8000A-ES510	5 Years Extended Warranty Service
MA80001A-ES210	2 Years Extended Warranty Service
MA80001A-ES310	3 Years Extended Warranty Service
MA80001A-ES510	5 Years Extended Warranty Service
MA80002A-ES210	2 Years Extended Warranty Service
MA80002A-ES310	3 Years Extended Warranty Service
MA80002A-ES510	5 Years Extended Warranty Service
MA80003A-ES210	2 Years Extended Warranty Service
MA80003A-ES310	3 Years Extended Warranty Service
MA80003A-ES510	5 Years Extended Warranty Service

### Related Products



Radio Communication Analyzer  
MT8821C



Signalling Tester  
MD8430A



Shield Box  
MA8161A



RF Chamber  
MA8171A



CATR Anechoic Chamber  
MA8172A

Typical (typ.): Performance not warranted. Must products meet typical performance.  
Nominal (nom.): Values not warranted. Included to facilitate application of product.





**• United States****Anritsu Americas Sales Company**

450 Century Parkway, Suite 190, Allen,  
TX 75013, U.S.A.

Phone: +1-800-Anritsu (1-800-267-4878)

**• Canada****Anritsu Electronics Ltd.**

700 Silver Seven Road, Suite 120, Kanata,  
Ontario K2V 1C3, Canada

Phone: +1-613-591-2003

Fax: +1-613-591-1006

**• Brazil****Anritsu Eletronica Ltda.**

Praça Amadeu Amaral, 27 - 1 Andar  
01327-010 - Bela Vista - Sao Paulo - SP, Brazil

Phone: +55-11-3283-2511

Fax: +55-11-3288-6940

**• Mexico****Anritsu Company, S.A. de C.V.**

Bldv Miguel de Cervantes Saavedra #169 Piso 1, Col. Granada

Mexico, Ciudad de Mexico, 11520, MEXICO

Phone: +52-55-4169-7104

**• United Kingdom****Anritsu EMEA Ltd.**

200 Capability Green, Luton, Bedfordshire, LU1 3LU, U.K.

Phone: +44-1582-433200

Fax: +44-1582-731303

**• France****Anritsu S.A.**

12 avenue du Québec, Bâtiment Iris 1- Silic 612,

91140 VILLEBON SUR YVETTE, France

Phone: +33-1-60-92-15-50

Fax: +33-1-64-46-10-65

**• Germany****Anritsu GmbH**

Nemetschek Haus, Konrad-Zuse-Platz 1

81829 München, Germany

Phone: +49-89-442308-0

Fax: +49-89-442308-55

**• Italy****Anritsu S.r.l.**

Via Elio Vittorini 129, 00144 Roma, Italy

Phone: +39-6-509-9711

Fax: +39-6-502-2425

**• Sweden****Anritsu AB**

Isafjordsgatan 32C, 164 40 KISTA, Sweden

Phone: +46-8-534-707-00

**• Finland****Anritsu AB**

Teknobulevardi 3-5, FI-01530 VANTAA, Finland

Phone: +358-20-741-8100

Fax: +358-20-741-8111

**• Denmark****Anritsu A/S**

c/o Regus Fairway, Arne Jacobsens Allé 7, 5th floor

2300 Copenhagen S, Denmark

Phone: +45-7211-2200

**• Russia****Anritsu EMEA Ltd.****Representation Office in Russia**

Tverskaya str. 16/2, bld. 1, 7th floor.

Moscow, 125009, Russia

Phone: +7-495-363-1694

Fax: +7-495-935-8962

**• Spain****Anritsu EMEA Ltd.****Representation Office in Spain**

Paseo de la Castellana, 141. Planta 5, Edificio Cuzco IV

28046, Madrid, Spain

Phone: +34-91-572-6761

**• United Arab Emirates****Anritsu EMEA Ltd.****Dubai Liaison Office**

902, Aurora Tower,

P O Box: 500311 - Dubai Internet City

Dubai, United Arab Emirates

Phone: +971-4-3758479

Fax: +971-4-4249036

**• India****Anritsu India Private Limited**

6th Floor, Indigube ETA, No.38/4, Adjacent to EMC2,

Doddanekundi, Outer Ring Road, Bengaluru - 560048, India

Phone: +91-80-6728-1300

Fax: +91-80-6728-1301

**• Singapore****Anritsu Pte. Ltd.**

11 Chang Charn Road, #04-01, Shriro House

Singapore 159640

Phone: +65-6282-2400

Fax: +65-6282-2533

**• P.R. China (Shanghai)****Anritsu (China) Co., Ltd.**

Room 2701-2705, Tower A,

New Caohejing International Business Center

No. 391 Gui Ping Road Shanghai, 200233, P.R. China

Phone: +86-21-6237-0898

Fax: +86-21-6237-0899

**• P.R. China (Hong Kong)****Anritsu Company Ltd.**

Unit 1006-7, 10/F., Greenfield Tower, Concordia Plaza,

No. 1 Science Museum Road, Tsim Sha Tsui East,

Kowloon, Hong Kong, P.R. China

Phone: +852-2301-4980

Fax: +852-2301-3545

**• Japan****Anritsu Corporation**

8-5, Tamura-cho, Atsugi-shi, Kanagawa, 243-0016 Japan

Phone: +81-46-296-6509

Fax: +81-46-225-8352

**• Korea****Anritsu Corporation, Ltd.**

5FL, 235 Pangyoeyeok-ro, Bundang-gu, Seongnam-si,

Gyeonggi-do, 13494 Korea

Phone: +82-31-696-7750

Fax: +82-31-696-7751

**• Australia****Anritsu Pty. Ltd.**

Unit 20, 21-35 Ricketts Road,

Mount Waverley, Victoria 3149, Australia

Phone: +61-3-9558-8177

Fax: +61-3-9558-8255

**• Taiwan****Anritsu Company Inc.**

7F, No. 316, Sec. 1, NeiHu Rd., Taipei 114, Taiwan

Phone: +886-2-8751-1816

Fax: +886-2-8751-1817