

Agilent 83000A Series Microwave System Amplifiers

Product Overview

Agilent Technologies Microwave System Amplifiers

- 83006A** 10 MHz to 26.5 GHz
- 83017A** 500 MHz to 26.5 GHz
- 83018A** 2 to 26.5 GHz
- 83020A** 2 to 26.5 GHz
- 83050A** 2 to 50 GHz
- 83051A** 45 MHz to 50 GHz

Features

- Ultra broadband to 50 GHz
- Up to 1 watt output power
- Compact size

Agilent Model (dBm)	Frequency (GHz)	Gain (dB)	Pout
83006A	0.01–26.5	20	13
83017A	0.5–26.5	25	18
83018A	2–26.5	27	24
83020A	2–26.5	30	30
83050A	2–50	21	18
83051A	0.045–50	23	12*

* 10 dbm 45–50 GHz

The Agilent microwave system amplifiers are compact, off-the-shelf amplifiers designed for systems designers and integrators. This family of amplifiers provides power where you need it to recover system losses and to boost available power in RF and microwave ATE systems.



The ultrabroad bandwidth from 10 MHz to 50 GHz allows the designer to replace several narrow bandwidth amplifiers with a single Agilent amplifier, eliminating the need for crossover networks or multiple bias supplies. The 83050A power amplifier and 83051A preamplifier expand frequency performance to 50 GHz, while the 1 Watt 83020A offers broadband power to 26 GHz. The small amplifier footprint allows for simple in-line insertion to existing system blocks that require amplification. The standard 83017A, 83018A, and 83020A include internal directional detectors for external leveling applications.

The 83020A is optionally available without the coupler-detector providing up to +30 dBm and +25 dBm, respectively. With excellent noise figure relative to their broad bandwidth and high gain, these amps significantly improve system noise figure and dynamic range. These products come equipped with a low profile heat sink, an integral mounting bracket, and a two-meter DC power supply cable. Thermal and power supply design allows fast, easy integration into most measurement systems.



Agilent Technologies

Applications

Small envelope size makes the Agilent Technologies family of microwave system amplifiers ideal for automated test and benchtop applications, offering the flexibility to place power where you need it.

Boost Source Output Power

Increase output power from microwave sources to increase test system dynamic range. Drive high input power devices such as TWTs, mixers, power amps, or optical modulators. Drive test devices into compression for device characterization.

Recover Systematic Losses

The microwave system amplifiers help solve the power loss from connectors, cables, switches, and signal routing components which consume valuable source power. Long transmission paths, common in antenna applications, are particularly susceptible to such losses.

Level Source Power

By using feedback to an external source ALC input, system designers can level output power at the test port, negating the effects of post-sweeper reflections and losses.

Simply route the directional detector output to the source external ALC input connector. The figures at right show typical results.

The 83020A, 83018A, and 83017A feature an integral directional detector to supply feedback. To level an 83006A amplifier, use the 0.01 to 26.5 GHz 83036C directional detector or the 1 to 26.5 GHz 87300C coupler with an 8474C detector.

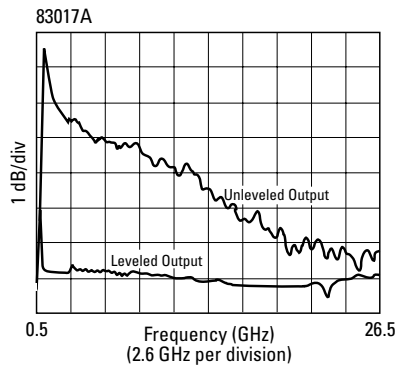
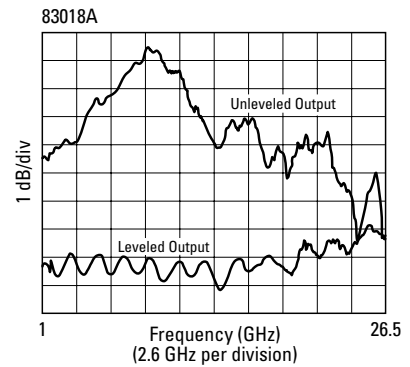
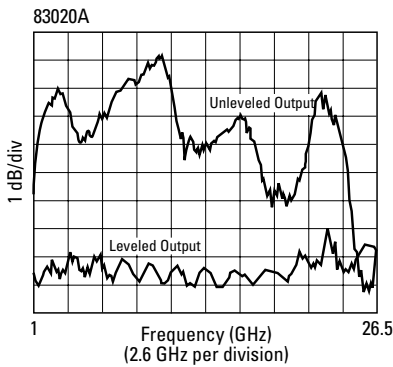
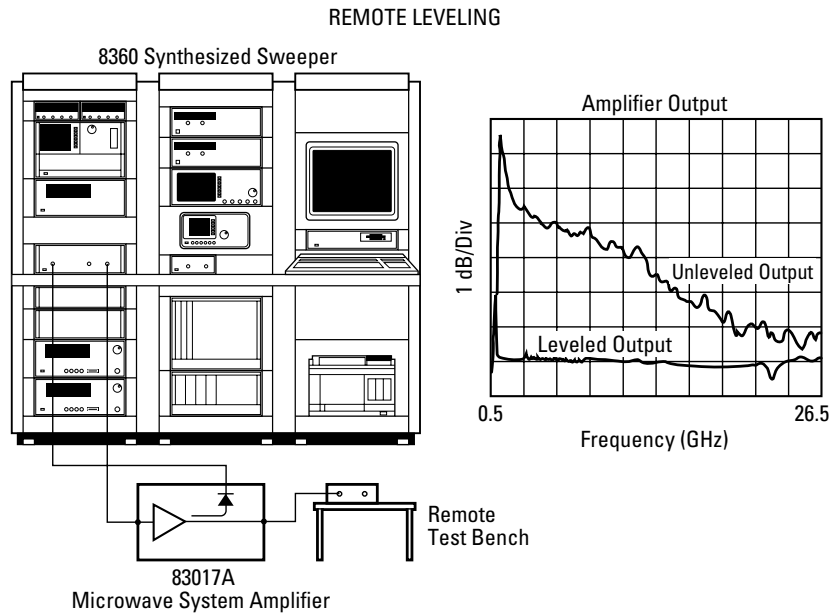

Improve Measurements

The 83006A, 83017A, and 83051A preamplifiers increase the sensitivity and dynamic range of spectrum analyzers. Add a preamplifier to noise figure measurement systems to significantly lower system noise figure. The table below shows typical system noise figure reduction achievable with these amplifiers. Note that the reduced system noise figure is dominated by the preamplifier noise figure. See Application Note 57-2, literature number 5952-3706.

Benchtop Gain Block

Benchtop microwave design tasks often require amplification to measure low level output characteristics, improve system dynamic range, perform saturation tests, or boost power levels. The Agilent family of system amplifiers offers small size and immediate, off-the-shelf solutions to microwave design, production, or test engineers.

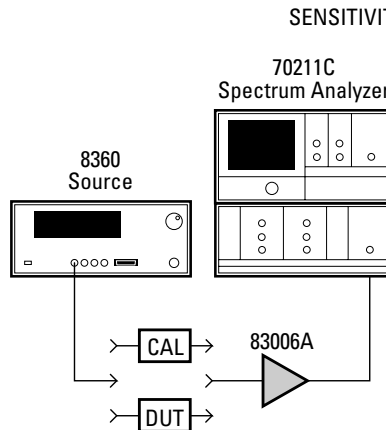

SENSITIVITY IMPROVEMENT

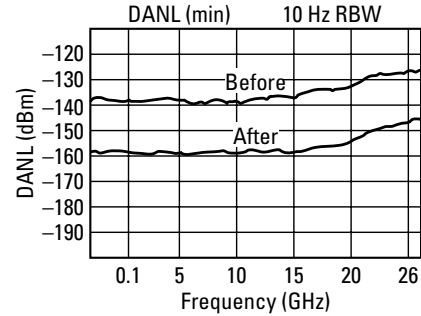

Pulse Parameter Measurements

Fast rise time and multi-octave bandwidth make these amplifiers attractive for fast pulse parameter measurements. The 0.01, 0.5, and 2 GHz cutoff frequencies make them more useful for RF or impulse measurements with low duration times.

$$F_{\text{new}} = F_{\text{pa}} + \frac{F_{\text{sys}} - 1}{G_{\text{pa}}}$$

All terms linear

Typical Noise Figure Improvement

Amp Model	Freq (GHz)	Max NF (dB)	Min Gain (dB)	System Noise Figure (F_{sys}) without preamp (dB)						
				13	15	18	20	23	25	30
83006A	0.01–0.2	13	20	—	13.1	13.1	13.2	13.4	13.6	14.8
	0.2–18	8	—	8.1	8.2	8.4	8.6	9.2	9.8	12.1
	18–26.5	13	—	—	13.1	13.1	13.2	13.4	13.6	14.8
83017A	0.5–18	8	25	8.0	8.1	8.1	8.2	8.4	8.6	9.8
	18–26.5	13	—	—	13.0	13.0	13.1	13.1	13.2	13.6
83018A	1–2	10	23	10.0	10.1	10.1	10.2	10.4	10.6	11.8
	2–20	10	27	10.0	10.0	10.1	10.1	10.2	10.3	10.8
	20–26.5	13	23	—	13.0	13.1	13.1	13.2	13.3	14.0
83020A	1–20	10	30	10.0	10.0	10.0	10.0	10.1	10.1	10.4
	20–26.5	13	27	—	13.0	13.1	13.1	13.1	13.1	13.4
85050A	2–26.5	6	21	6.1	6.2	6.3	6.5	7.0	7.5	9.5
	26.5–50	10	—	10.0	10.1	10.1	10.2	10.4	10.6	11.8
83051A	0.045–2	12	23	12.0	12.0	12.1	12.1	12.3	12.4	13.2
	2–26.5	6	—	6.1	6.2	6.3	6.5	7.0	7.5	9.5
	26.5–50	10	—	10.0	10.1	10.1	10.2	10.4	10.6	11.8

Product Specifications

Model Number	83006A	83017A	83018A
Frequency Range	10 MHz–26.5 GHz	0.5–26.5 GHz	2–26.5 GHz
Small Signal Gain	20 dB min	25 dB min	23 dB typ 1–2 GHz 27 dB min 2–20 GHz 23 dB min 20–26.5 GHz
Small Signal Gain Flatness	±5 dB max 0.01–5 GHz ±3 dB max 5–26.5 GHz	±5 dB max 0.5–2 GHz ±5 dB max 2–26.5 GHz	±5 dB typ
Output Power (At P max)	+18 dBm typ 0.01–10 GHz +16 dBm typ 10–20 GHz +14 dBm typ 20–26.5 GHz	+20 dBm typ 0.5–20 GHz +15 dBm typ 20–26.5 GHz	+23 dBm typ 1–2 GHz ² +24 dBm min 2–20 GHz ^{2,3} +21 dBm min 20–26.5 GHz ^{2,3}
(At 1 dB compression)	+13 dBm min 0.01–20 GHz +10 dBm min 20–26.5 GHz	+18 dBm min 0.5–20 GHz +18 dBm–0.75 dB/GHz (20<f<26.5 GHz)	+22 dBm typ 1–2 GHz +22 dBm min 2–20 GHz +17 dBm min 20–26.5 GHz
Leveled Output Power Flatness ¹	N/A	±1.1 dB 0.5–26.5 GHz at 12 dBm ±1.5 dB 0.5–20 GHz at 18 dBm	±1.5 dB 1–26.5 GHz at 17 dBm
Noise Figure	<13 dB typ 0.01–0.1 GHz <8 dB typ 0.1–18 GHz <13 dB typ 18–26.5 GHz	<8 dB typ 0.5–20 GHz <13 dB typ 20–26.5 GHz	<10 dB typ 1–20 GHz <13 dB typ 20–26.5 GHz
Harmonics (At spec'd value of P1 dBC)	–25 dBc 0.01–11 GHz –25 dBc typ 11–13.25 GHz	–20 dBc 0.5–11 GHz –20 dBc typ 11–13.25 GHz	–22 dBc typ 1–2 GHz –19 dBc 2–11 GHz –19 dBc typ 11–13.25 GHz
Harmonics (At spec'd max power)	N/A	N/A	–20 dBc typ 1–2 GHz –17 dBc typ 2–11 GHz –17 dBc typ 11–13.25 GHz
Input SWR	2.6:1	2.6:1	3:1 typ 1–2 GHz 3:1 2–26.5 GHz
Output SWR	2.8:1 0.01–18 GHz 3.2:1 18–26.5 GHz	2.6:1	7.0:1 typ 1–2 GHz 4.5:1 2–10 GHz 2.2:1 10–26.5 GHz
Non-Harmonically Related Spurious	–65 dBc typ	–65 dBc typ	–65 dBc typ
Rise Time	400 ps typ	310 ps typ	275 ps typ
Third Order Intercept (TOI)	30 dBm typ at 2 GHz 20 dBm typ at 26.5 GHz	30 dBm typ at 2 GHz 20 dBm typ at 26.5 GHz	36 dBm typ 2–20 GHz 31 dBm typ 20–26.5 GHz
Impedance	50Ω typ	50Ω typ	50Ω typ
Reverse Isolation (typ)	–65 dB	–65 dB	–55 dB at 1 GHz +0.95 dB/GHz
Survival Input Power	+23 dBm max	+23 dBm max	+23 dBm max
Power Dissipation	6 W	9 W	24 W

1. At min specified P1 dBC within given frequency band
2. P max measured with 0 dBm input
3. Option 001 Pmax +25 dBm 2–20 GHz, +22 dBm 20–26.5 GHz

Product Specifications (continued)

Model Number	83020A	83050A	83051A
Frequency Range	2–26.5 GHz	2–50 GHz	45 MHz–50 GHz
Small Signal Gain	30 dB typ 1–2 GHz 30 dB min 2–20 GHz 27 dB min 20–26.5 GHz	21 dB min	23 dB min
Small Signal Gain Flatness	±5 dB typ	±3.5 dB max	±3.5 dB max
Output Power (At P max)	+30 dBm typ 1–2 GHz ² +30 dBm min 2–20 GHz ^{2,3} +30 dBm –0.7 dB/GHz ^{2,3} (20<f<26.5 GHz)	+20 dBm 2–40 GHz +19 dBm–0.2 dB/GHz (40<f<50 GHz)	+12 dBm to 45 GHz +10 dBm 45–50 GHz
(At 1 dB compression)	+28 dBm typ 1–2 GHz +28 dBm min 2–20 GHz +28 dBm–0.7 dB/GHz (20<f<26.5 GHz)	+15 dBm 2–40 GHz +13 dBm 40–50 GHz	+8 dBm 45 MHz–45 GHz +6 dBm 45–50 GHz
Leveled Output Power Flatness ¹	±1.5 dB typ 1–26.5 GHz At 23 dBm	N/A	N/A
Noise Figure	<10 dB typ 1–20 GHz <13 dB typ 20–26.5 GHz	<6 dB typ 2–26.5 GHz <10 dB typ 26.5–50 GHz	<12 dB typ 45 MHz–2 GHz <6 dB typ 2–26.5 GHz <10 dB typ 26.5–50 GHz
Harmonics (At Spec'd value of P1 dBC)	–22 dBc typ 1–2 GHz –20 dBc typ 2–11 GHz –17 dBc typ 11–13.25 GHz	–20 dBc typ 2–18 GHz –18 dBc typ 18–25 GHz	–20 dBc typ 45 MHz–18 GHz –18 dBc typ 18–25 GHz
Harmonics (At Spec'd max power)	–20 dBc typ 1–2 GHz –17 dBc typ 2–11 GHz –17 dBc typ 11–13.25 GHz	N/A	N/A
Input SWR	3:1 typ 1–26.5 GHz	2.1 max	2.1 max
Output SWR	7.0:1 typ 1–2 GHz 4.5:1 2–10 GHz 2.2:1 10–26.5 GHz	2.8 max 2–18 GHz 2.1 max 18–50 GHz	2.2 max
Non-Harmonically Related Spurious	–65 dBc typ	–50 dBc typ	–50 dBc typ
Rise Time	375 ps typ	250 ps typ	225 ps typ
Third Order Intercept (TOI)	38 dBm typ 2–20 GHz 33 dBm typ 20–26.5 GHz	27 dBm typ	27 dBm typ
Impedance	50Ω typ	50Ω typ	50Ω typ
Reverse Isolation (typ)	–55 dB	–50 dB typ	–50 dB typ
Survival Input Power	+23 dBm max	+20 dBm max	+20 dBm max
Power Dissipation	48 W	11 W	5 W

1. At min specified P1 dBC within given frequency band

2. P max measured with +5 dBm input

3. Option 001 deletes detected output, for Pmax add 0.5 dBm 1–26.5 GHz

Special Applications: Higher performance models available upon request (i.e., higher power, etc.)

General Specifications

Model Number	83006A	83017A	83018A
*Bias Voltage and Current (nominal) mA	12 ±1 Vdc at 450 mA -12 ±1 Vdc at 50 mA	12 ±1 Vdc at 700 mA -12 ±1 Vdc at 50 mA	12 ±1 Vdc at 2A -12 ±1 Vdc at 50
RF Connectors	3.5 mm (f)	3.5 mm (f)	3.5 mm (f)
Detector Output	N/A	BNC (f)	BNC (f)
Detector Sensitivity	N/A	15µV/µW	4µV/µW
Detector Polarity	N/A	Negative	Negative
Weight: net shipping	0.64 kg (1.4 lb) 1.32 kg (2.9 lb)	0.64 kg (1.4 lb) 1.32 kg (2.9 lb)	1.8 kg (4.0 lb) 2.9 kg (6.4 lb)

*Do not apply positive voltage before negative voltage.

Environmental Specifications

Temperature Coefficient of Gain	-0.07 dB/° C	-0.1 dB/° C	-0.13 dB/° C
Operating Temperature	0 to +55° C	0 to +55° C	0 to +55° C
Storage Temperature	-40 to +70° C	-40 to +70° C	-40 to +70° C

Other Environmental Information

EMC¹	IEC 61326:1997/EN 61326:1997 CISPR 11:1997/EN 55011:1998, Group 1, Class A
Safety	IEC 348:1978/HD 401 S1:1981 CAN/CSA-C22.2 No. 231 (Series M-89)
Moisture Resistance	65° C at 95% RH for 10 days per Mil-Std-883C method 1004.5
Random Vibration	5.2 G (rms) to 2000 Hz per Mil-Std-883C method 2026 test condition 11A
Shock	1500 G (peak), 0.5 ms per Mil-Std-883C method 2002.3 test condition B
Altitude, non-operating	15,000 m per Mil-Std-883C method 1001 test condition C

1. This ISM device complies with Canadian ICES-001. Cet appareil ISM est conforme a la norme NMB-001 du Canada.

General Specifications (continued)

Model Number	83020A	83050A	83051A
*Bias Voltage and Current (nominal)	15 ±1.5 Vdc at 3.2A –15 ±0.5 Vdc at 40 mA	12 ±1 Vdc at 830 mA –12 ±1 Vdc at 50 mA	12 ±1 Vdc at 425 mA –12 ±1 Vdc at 50 mA
RF Connectors	3.5 mm (f)	2.4 mm (f)	2.4 mm (f)
Detector Output	BNC (f)	N/A	N/A
Detector Sensitivity	1 µV/µW	N/A	N/A
Detector Polarity	Negative	N/A	N/A
Weight: net shipping	3.9 kg (8.5 lb) 5.0 kg (11 lb)	0.64 kg (1.4 lb) 1.32 kg (2.9 lb)	0.64 kg (1.4 lb) 1.32 kg (2.9 lb)

*Do not apply positive voltage before negative voltage.

Environmental Specifications

Temperature Coefficient of Gain	–0.19 dB/° C	–0.09 dB/° C	–0.09 dB/° C
Operating Temperature	0 to +55° C	0 to +55° C	0 to +55° C
Storage Temperature	–40 to +70° C	–40 to +70° C	–40 to +70° C

Other Environmental Information

EMC:¹	IEC 61326:1997/EN 61326:1997 CISPR 11:1997/EN 55011:1998, Group 1, Class A
Safety:	IEC 348:1978/HD 401 S1:1981 CAN/CSA-C22.2 No. 231 (Series M-89)
Moisture Resistance	65° C at 95% RH for 10 days per Mil-Std-883C method 1004.5
Random Vibration	5.2 G (rms) to 2000 Hz per Mil-Std-883C method 2026 test condition 11A
Shock	1500 G (peak), 0.5 ms per Mil-Std-883C method 2002.3 test condition B
Altitude, non-operating	15,000 m per Mil-Std-883C method 1001 test condition C

1. This ISM device complies with Canadian ICES-001. Cet appareil ISM est conforme a la norme NMB -001 du Canada.

Specifications: describe the instrument's warranted performance over the temperature range +20° C to +30° C (unless otherwise noted). All specifications apply after the instrument's temperature has been stabilized after one hour continuous operation. Typical characteristics are intended to provide information useful in applying the instrument by giving typical but nonwarranted performance parameters. These are denoted as "typical" or "nominal" and apply over the temperature range +20° C to +30° C.

Caution on Electrostatic Discharge: Electrostatic discharge (ESD) can damage or destroy electronic components. It is recommended that these amplifiers, like other electronic components, be installed and operated at a static-free workstation or in an environment where precautions against ESD have been implemented.

Graphical Performance Data

83006A Amplifier

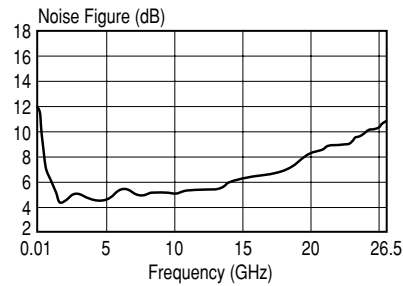
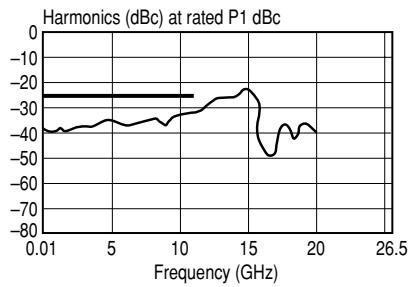
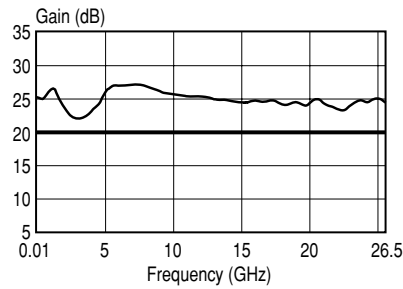
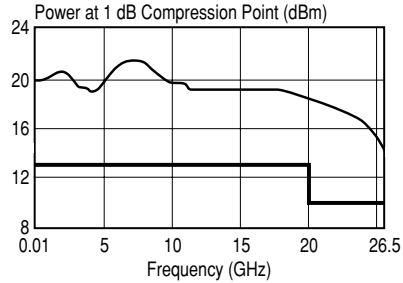

83017A Amplifier

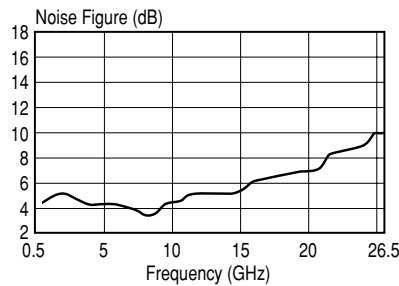
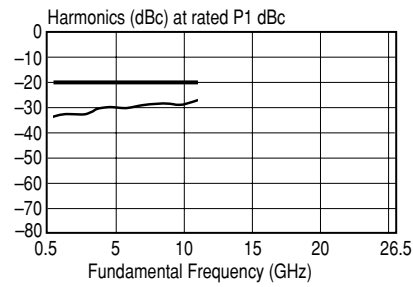
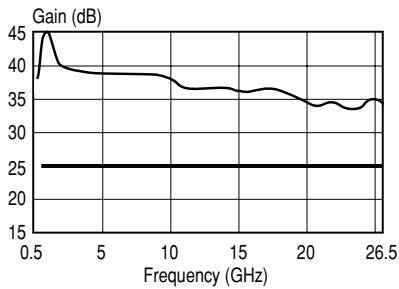
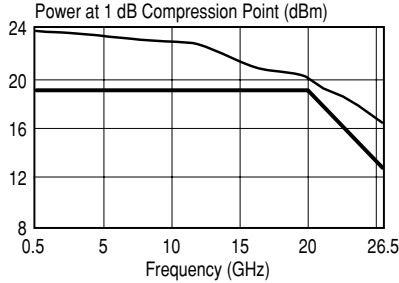

83018A Amplifier

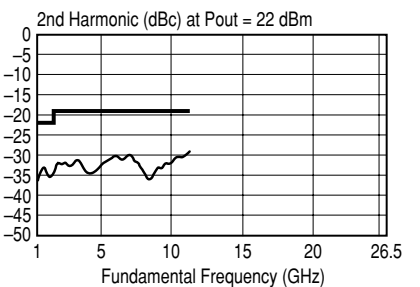
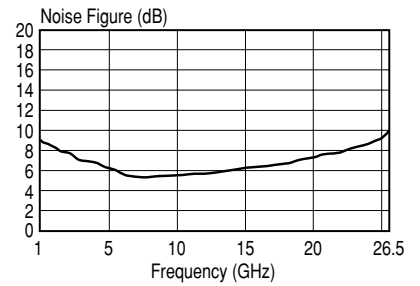
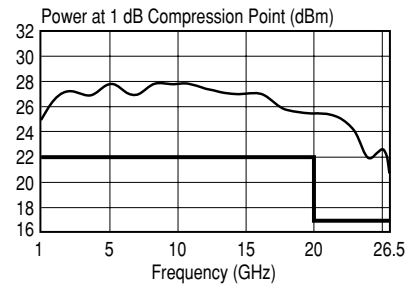
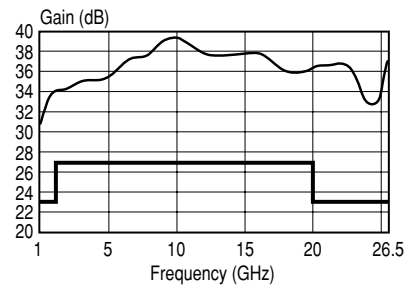
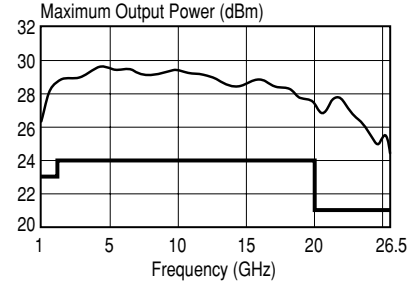

Graphical Performance Data (continued)

83020A Amplifier

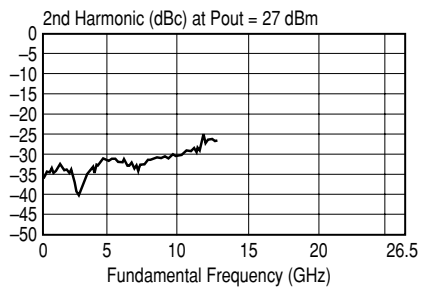
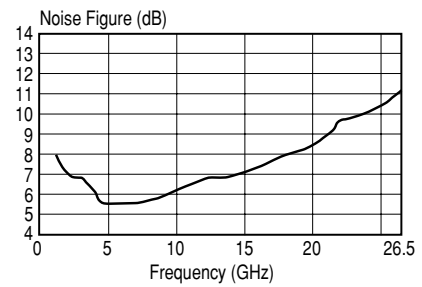
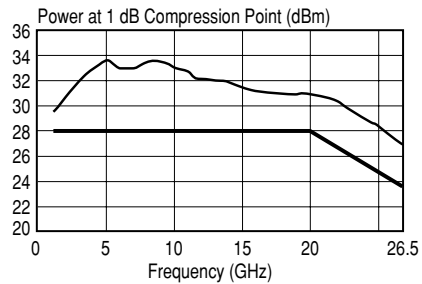
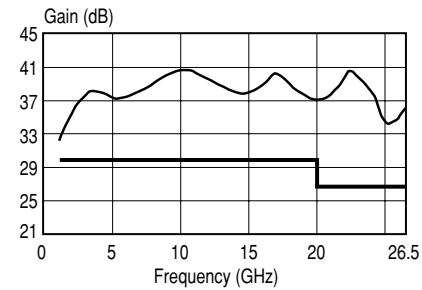
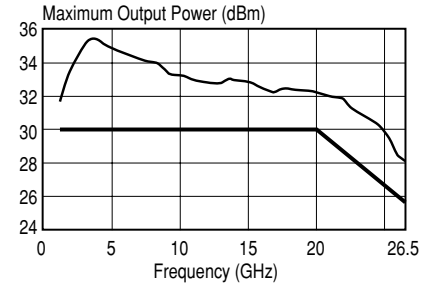

83050A Amplifier

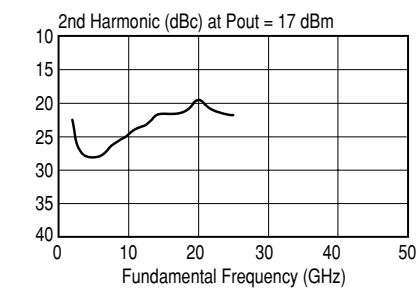
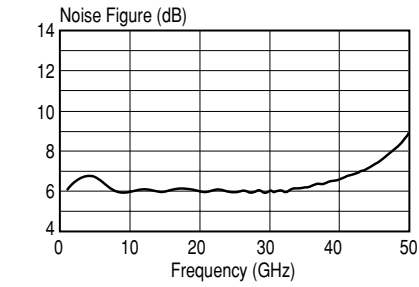
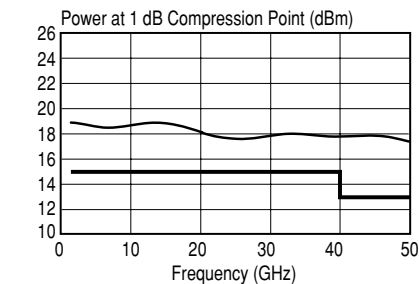
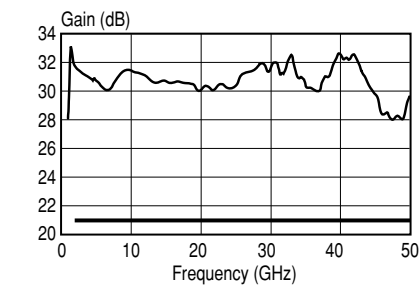
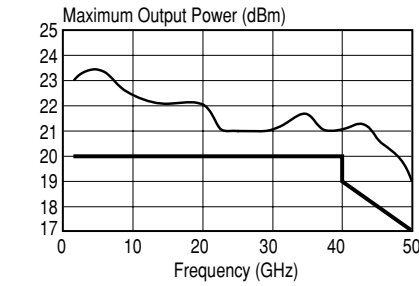

83051A Amplifier

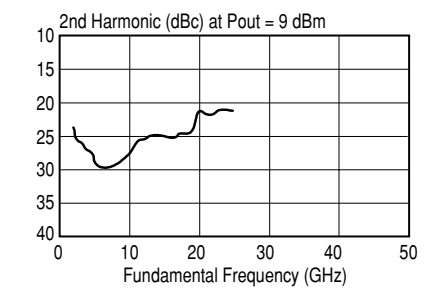
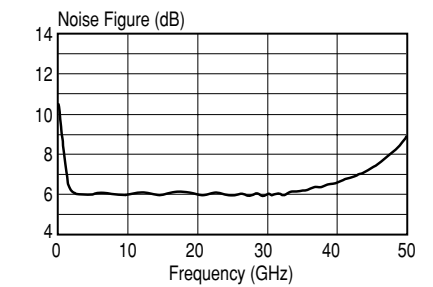
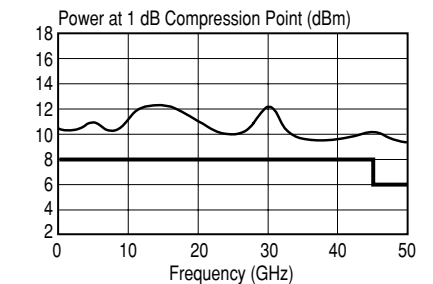
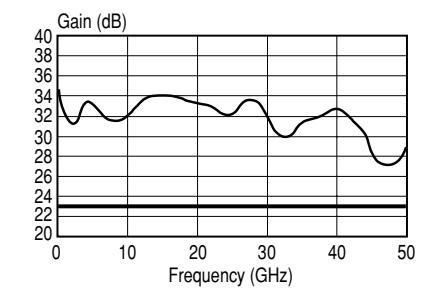
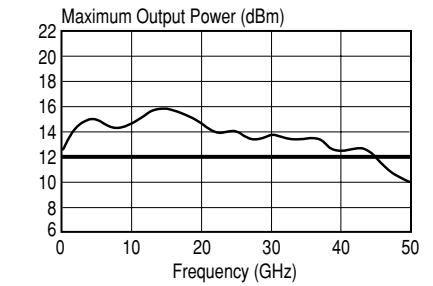

Amplifier Outline Drawings¹

83006A

Tol = ±0.2 (0.008)

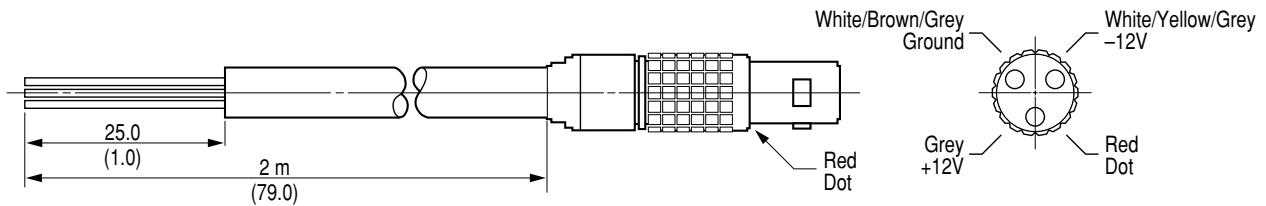
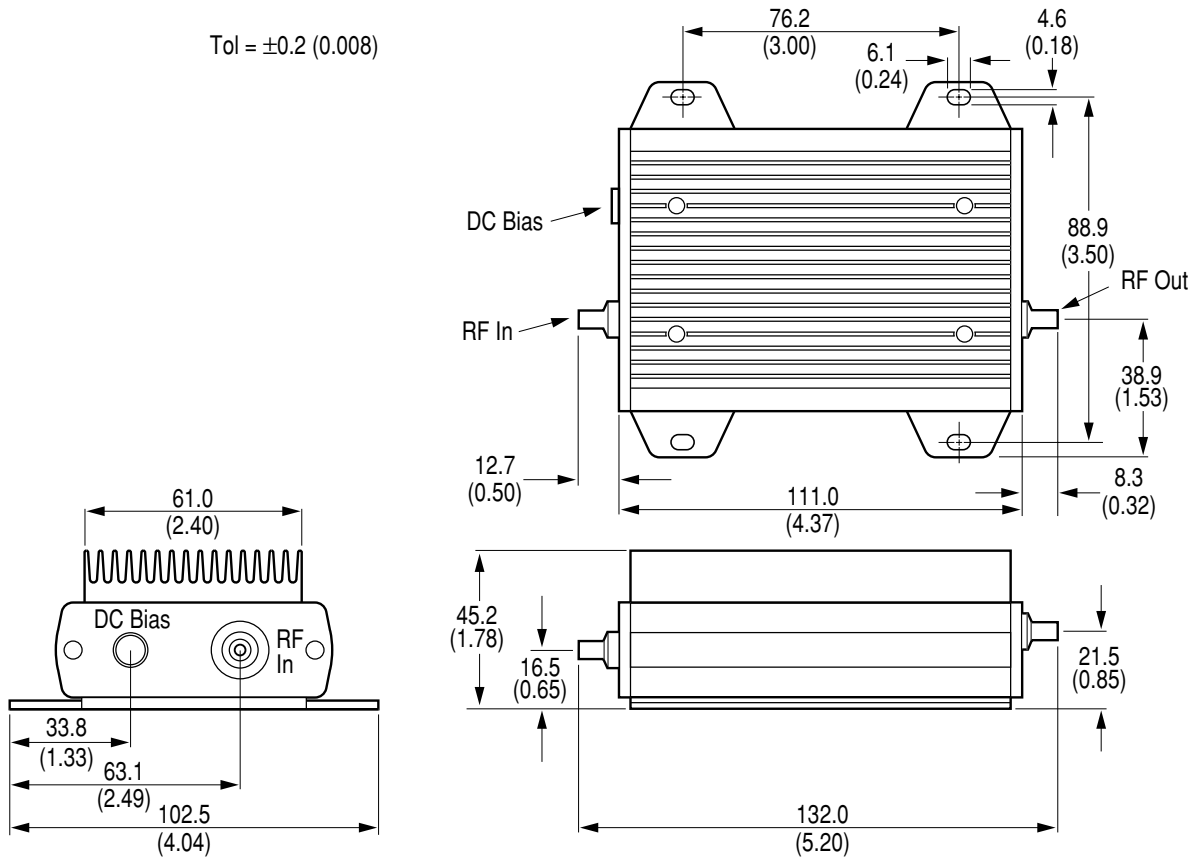

83006-60004 dc bias cable. Cable shipped with 8300A, 83017A, 83018A, 83050A, and 83051A.

1. Dimensions in millimeters and (inches).

Amplifier Outline Drawings (continued)

83017A

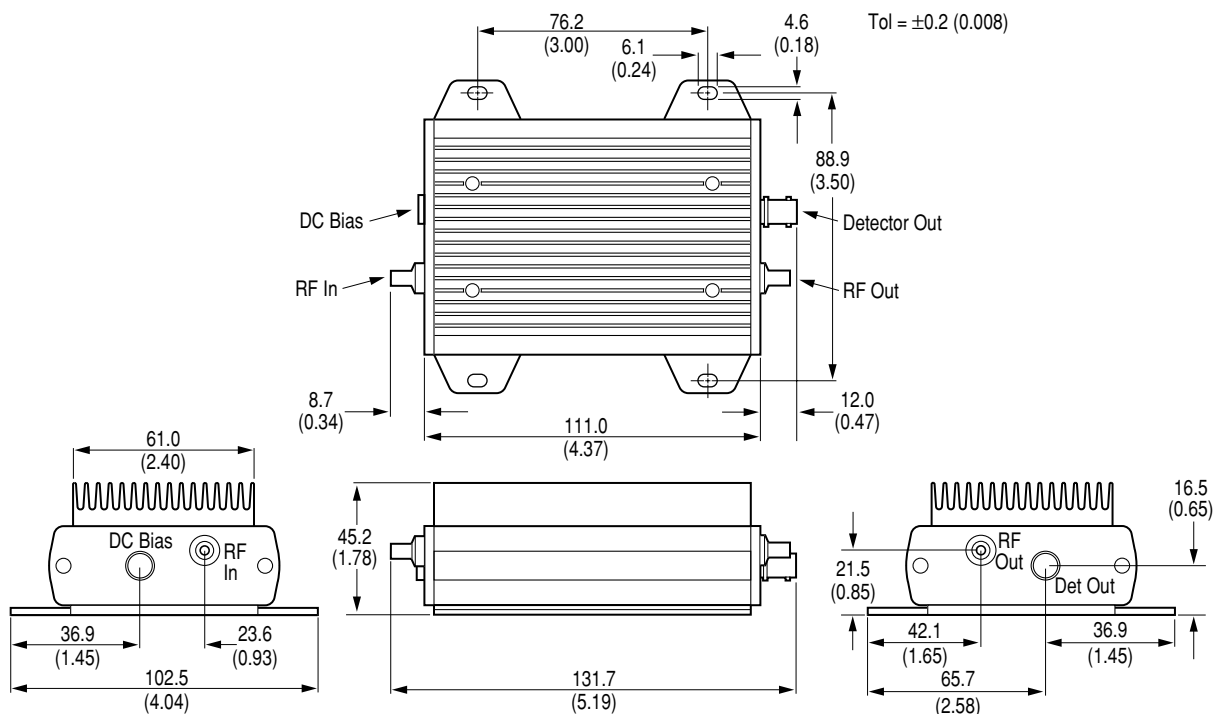

83018A

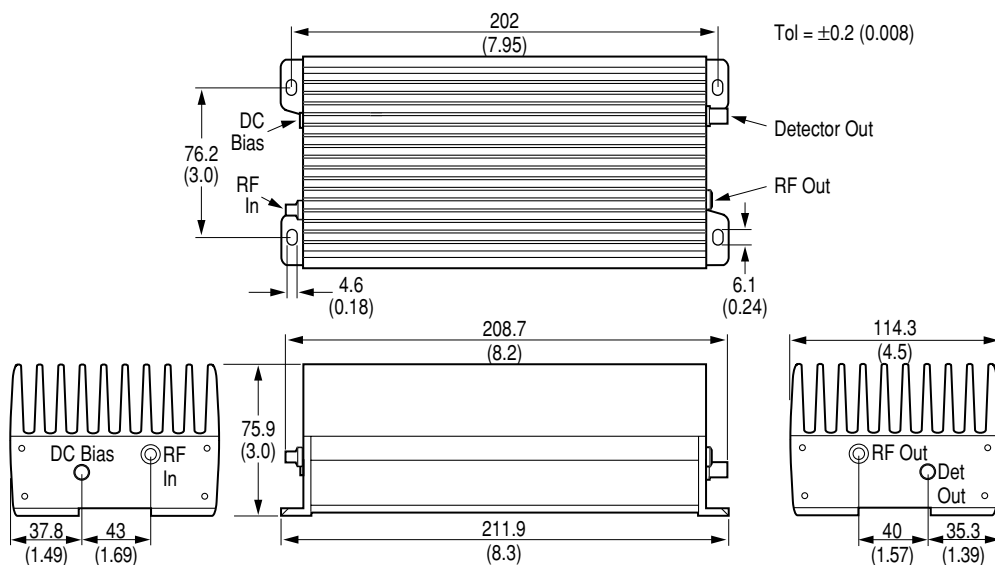

Amplifier Outline Drawings (continued)

83020A

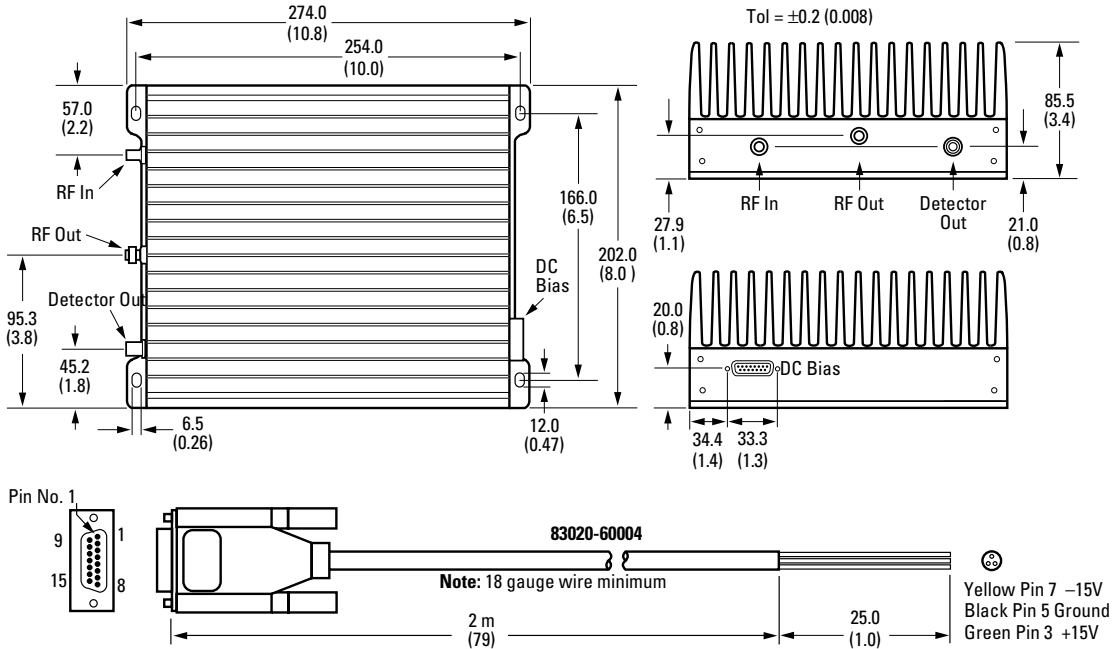

83050A and 83051A

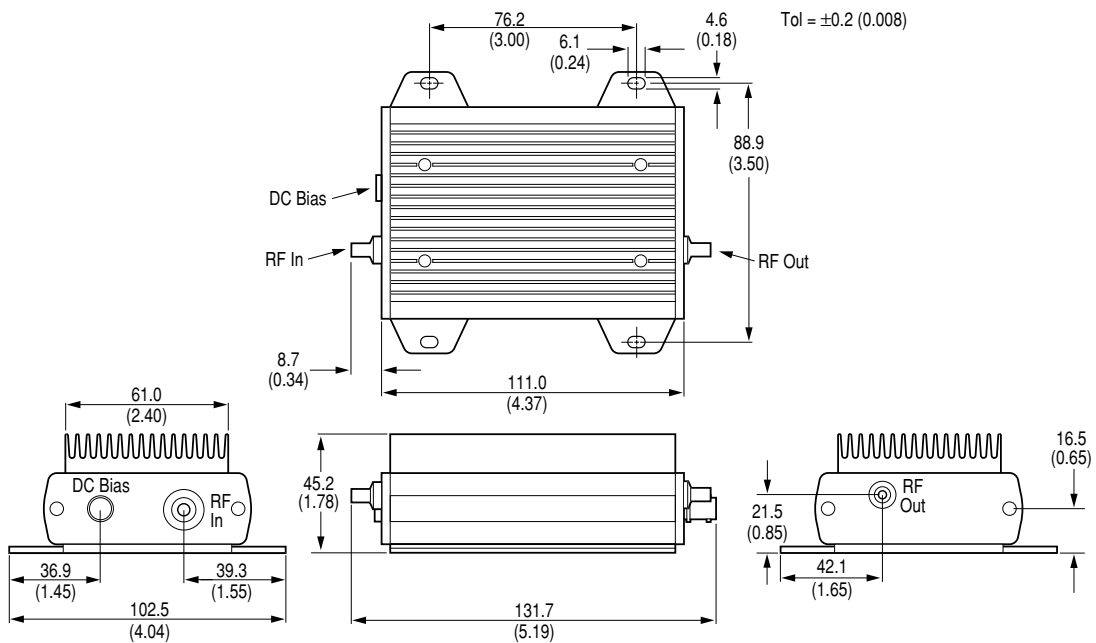

Power Supply Outline Drawings

87421A

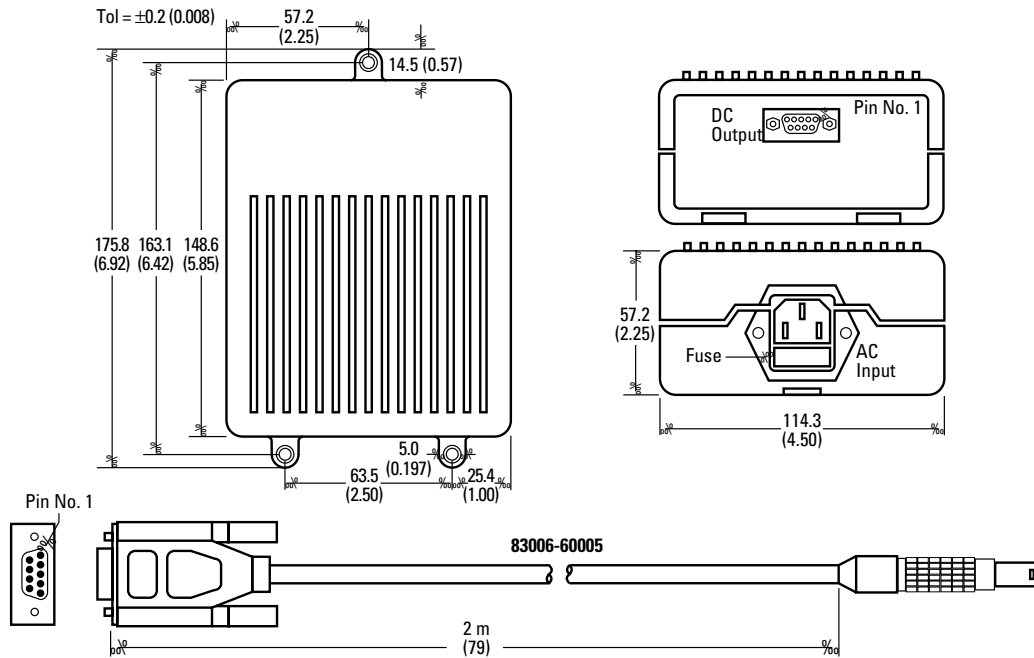

The 87421A power supply provides the dc power needed to bias the 83006A, 83017A, 83018A, 83050A, and 83051A.

87422A

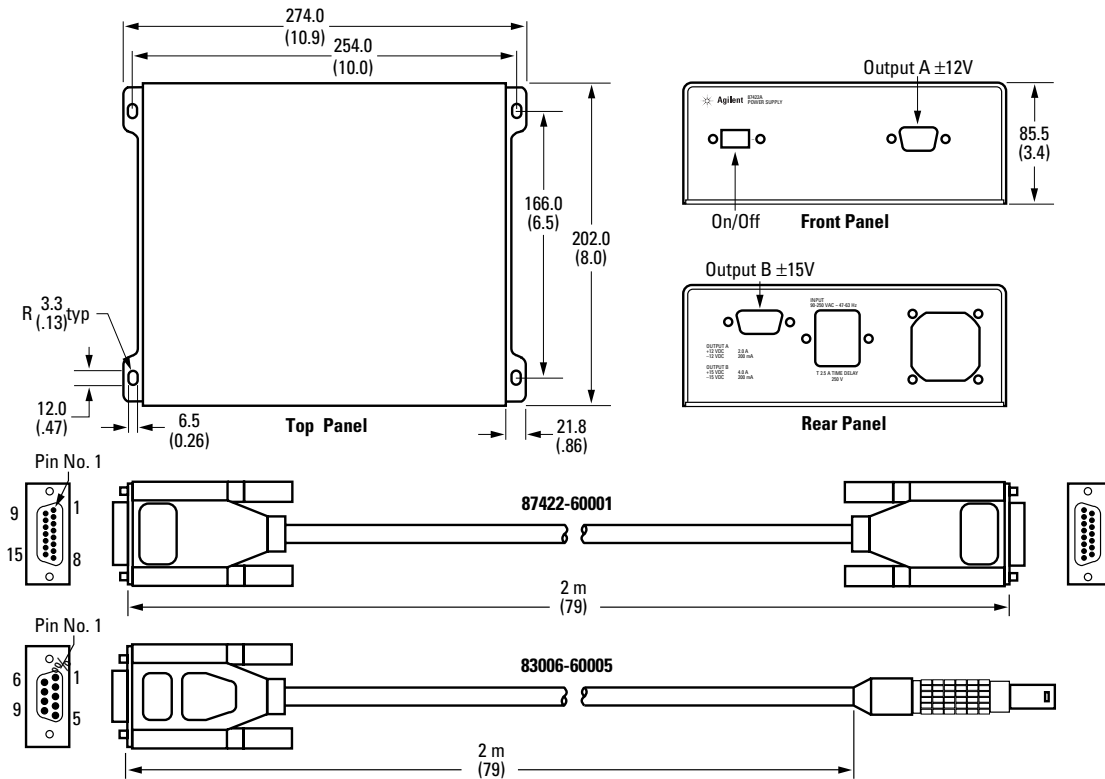

The 87422A power supply provides the dc power needed to bias the 8302A, plus an additional ±12V dc output.

Ordering Information

Agilent 83006A, 83017A, 83050A, and 83051A microwave system amplifiers

Includes amplifier and part number 83006-60004, which is a two-meter cable with a three-pin connector on one end and three-wire leads on the other end.

Agilent 83018A microwave system amplifier

Includes amplifier and part number 83006-60004, which is a two-meter cable with a three-pin connector on one end and three-wire leads on the other end.

- **Special Applications:** Higher performance models available upon request.

Agilent 83020A microwave system power amplifier

Includes amplifier and part number 83020-60004, which is a two-meter cable with a fifteen-pin connector on one end and three-wire leads on the other end.

- **Option 001:** Delete coupler/detector providing higher output power.
- **Special Applications:** Higher performance models available upon request.

Other Instruments and Accessories

Agilent 83036C coaxial GaAs directional detector

0.01–26.5 GHz, for use with the 83006A.

Agilent 87421A power supply

Includes power supply and part number 83006-60005, which is a two-meter cable with a three-pin connector on one end and a D-sub-miniature connector on the other end for direct connection to the 83006A, 83017A, 83018A, 83050A, and 83051A.

Agilent 87422A power supply

Includes power supply and part number 83020-60001, which is a two-meter cable with fifteen-pin connectors for direct connection to the 83020A amplifier. One additional cable, part number 83006-60005, is provided for direct connection of the 12V dc output to a preamplifier such as the 83006A, 83017A, 83018A, 83050A, or 83051A.

Related Literature

Agilent 83036C
data sheet, **5952-1874**

Agilent 87421A/87422A
data sheet, **5091-4292E**

Agilent Technologies' Test and Measurement Support, Services, and Assistance

Agilent Technologies aims to maximize the value you receive, while minimizing your risk and problems. We strive to ensure that you get the test and measurement capabilities you paid for and obtain the support you need. Our extensive support resources and services can help you choose the right Agilent products for your applications and apply them successfully. Every instrument and system we sell has a global warranty. Support is available for at least five years beyond the production life of the product. Two concepts underlie Agilent's overall support policy: "Our Promise" and "Your Advantage."

Our Promise

Our Promise means your Agilent test and measurement equipment will meet its advertised performance and functionality. When you are choosing new equipment, we will help you with product information, including realistic performance specifications and practical recommendations from experienced test engineers. When you use Agilent equipment, we can verify that it works properly, help with product operation, and provide basic measurement assistance for the use of specified capabilities, at no extra cost upon request. Many self-help tools are available.

Your Advantage

Your Advantage means that Agilent offers a wide range of additional expert test and measurement services, which you can purchase according to your unique technical and business needs. Solve problems efficiently and gain a competitive edge by contracting with us for calibration, extra-cost upgrades, out-of-warranty repairs, and onsite education and training, as well as design, system integration, project management, and other professional engineering services. Experienced Agilent engineers and technicians worldwide can help you maximize your productivity, optimize the return on investment of your Agilent instruments and systems, and obtain dependable measurement accuracy for the life of those products.

Agilent T&M Software and Connectivity

Agilent's Test and Measurement software and connectivity products, solutions and developer network allows you to take time out of connecting your instruments to your computer with tools based on PC standards, so you can focus on your tasks, not on your connections. Visit www.agilent.com/find/connectivity for more information.

By internet, phone, or fax, get assistance with all your test & measurement needs

Phone or Fax

United States:
(tel) 800 452 4844

Korea:
(tel) (82 2) 2004 5004
(fax) (82 2) 2004 5115

Canada:
(tel) 877 894 4414
(fax) 905 282 6495

Latin America:
(tel) (305) 269 7500
(fax) (305) 269 7599

China:
(tel) 800 810 0189
(fax) 800 820 2816

Taiwan:
(tel) 0800 047 866
(fax) 0800 286 331

Europe:
(tel) (31 20) 547 2323
(fax) (31 20) 547 2390

Other Asia Pacific
Countries:
(tel) (65) 6375 8100
(fax) (65) 6836 0252

Japan:
(tel) (81) 426 56 7832
(fax) (81) 426 56 7840

Email:
tm_asia@agilent.com



Agilent Email Updates

www.agilent.com/find/emailupdates

Get the latest information on the products and applications you select.

Product specifications and descriptions in this document subject to change without notice.

© Agilent Technologies, Inc. 2002
Printed in USA, October 14, 2002
5963-5110E



Agilent Technologies