

Anritsu

ML2400A Series

Power Meters



Power meters that give you more.

ANRITSU POWER METERS GIVE YOU MORE

High Reliability. Rugged, splash resistant chassis design handles drop shocks and rough field treatment. A front panel cover and softcase are optional for further environmental protection.

Graphics Display. Up to 100k samples per second produces accurate profiles of cellular, PCS, radar, aircraft control, and telemetry signals. Pulse top power is easily measured and averaged over single or multiple pulses.

Peaking Meter. A dual bar graph aids tuning procedures.

Softkeys. Menu driven operation simplifies test procedures

Trigger Key. Triggering controls apply high measurement speed precisely when it's needed. Perform on-pulse measurements over more than 80 dB dynamic range.

Sensor EEPROM. All MA2400A/B Series sensors have built-in EEPROMs with factory Calibration Factor data. Six User Calibration Factor Tables allow extra frequency points or compensation for couplers and power attenuators.

Accuracy. Excellent return loss sensor design reduces typical mismatch uncertainty by half - improving accuracy and repeatability. Less SWR ripple in measurement data improves production yield and quality control.



High Speed GPIB.
The ML2430A incorporates a RISC processor with a companion high speed DSP processor. An internal high performance GPIB chip delivers an industry leading > 600 rdgs/sec.

Min/Max. Monitor total power excursion in either readout or graphical profiling mode displays.

Voltage. Fast voltage measurements monitor bias conditions.

90 dB Sensor Range.
One MA2472A Power Sensor replaces two traditional 50 dB sensors and eliminates the need for switching and settling software in ATE systems.

Blazing Speed.
Fast Thermal Sensors increase settling speed more than an order of magnitude.

ML2407/08A for N-CDMA and Narrow Pulse Power Measurements

ML2407A is the ideal solution for accurate measurements of IS-95 signals, giving average, peak and crest readings

Pulses down to 1 μ s can be captured and displayed in graphical mode thanks to the 0.6 μ s rise time of the MA2469A sensor. Test amplifiers response to narrow input pulses.

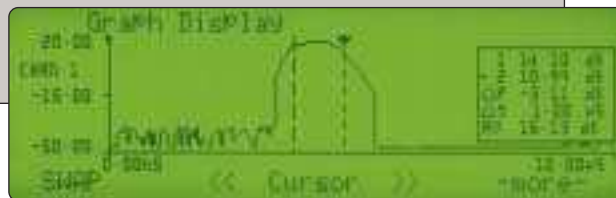

Printer.
Document signal performance quickly with the standard parallel printer output.

Options 6 - 10.
Sensor and calibrator connectors (not shown in photo) can be located on the rear panel.

High Speed GPIB.
Accelerate ATE throughput with special "Fast mode"

Analog Outputs.
Dual analog outputs support corrected and scaled measurements or realtime dual channel output. Synthesizer interface controls include zero blanking.

Optional NiMH Battery
Provides 6 hours continuous operation.

Voltage Input.
The analog input measures voltage or accepts the V/GHz signal from a synthesizer for automated sensor calibration factor correction.

TTL Trigger.
Precisely control peak power measurements and the start/stop timing of burst measurements.

ACCURACY, SPEED, FLEXIBILITY, ML2400A SERIES HAS IT ALL

COMPREHENSIVE RANGE OF POWER SENSORS

Fast Thermal Sensors

Anritsu's thermal sensors provide excellent power measurement accuracy over 50dB of dynamic range with more speed than any other thermal sensor available. Thermal sensors use Seebeck elements where the combined effect of a thermal gradient and charge migration between dissimilar metals gives a true reading of average power on any incident waveform. Anritsu thermal sensors have class leading SWR and built in EEPROM with calibration factor and linearity correction data. This results in assured accuracy when measuring any signal. Anritsu's fast thermal power sensors improve sensor rise time and fall time to less than 4.0ms— an order of magnitude

faster than previous thermal sensors. Settled power measurements are now 10 times faster, that means reduced test time.

Standard Diode Sensors

Diode sensors have greater speed, sensitivity and dynamic range than thermal sensors. All Anritsu diode sensors use a dual diode architecture that gives improved sensitivity and dynamic range over single diode architectures. The MA2470A Series Power Sensors 90 dB dynamic range is both fast and accurate. Linearity is better than 1.8%, typically < 1.0% through 18 GHz. The ML2400A Series Power Meters allow test engineers to adjust low-level averaging controls for

optimization of GPIB speed, sensor settling, and noise reduction – allowing the industry's fastest -70 dBm settling time.

MA2470A power sensors offer an ideal combination of speed and dynamic range for general purpose power measurements. A single sensor replaces the two sensors that were previously required with sensors limited to 50dB dynamic range.

High Accuracy Diode Sensors

The Anritsu MA2440A series high accuracy diode sensors have a built in 3 dB attenuator to minimize input SWR. They are used where the best measurement accuracy is required over

Sensor EEPROM

All MA2400A/B Series Power Sensors through 50GHz store calibration data and model information within internal EEPROMS. The ATE system can automatically monitor system configuration - ensuring accurate, calibrated measurements.



Using the rear panel V/GHz input automates sensor calibration factor correction. The adjustable scale is compatible with most commercial synthesizers. Automatic calibration factor correction simplifies procedures and minimizes the opportunity for operator errors.

Most ATE systems use multiple power sensors. When those sensors lack EEPROMs, the ATE system requires elaborate data entry screens and database management to store the sensor cal factor data. Further, operators must be trained to look for the annual calibration report - rather than the potentially dated table on the sensor housing - before entering the data.

ATE designers no longer need to track sensor serial numbers and cal factor data programmatically in the system control software. The MA2400A/B Series' internal EEPROM has several benefits. Operator intervention is reduced. Significant ATE programming is eliminated. Accuracy and verifiable calibration configuration are assured.

High Power Applications

Traditional high power sensors are expensive and have degraded accuracy specifications. Further, annual calibrations require more time and expense. Anritsu's new User Calibration Factor Tables avoid these problems. Any attenuator or coupler can be compensated by entering frequency and attenuation values into the MA2400A/B Series Power Sensors

internal EEPROM. Six tables can be stored. The attenuation device can be semi-permanently attached; the power meter automatically applies compensation during the 0.0dBm, 50MHz calibration reference process. The User Calibration Factor Tables are easily deactivated - allowing the power sensor to be used stand-alone also.

a large dynamic range, for example when measuring amplifiers. High accuracy diode sensors have a dynamic range of 87 dB compared to the 90 dB of standard diode sensors.

Fast Diode Sensors

The MA2460A fast diode sensors from Anritsu have a rise time of 0.6µs. This together with a sensor video bandwidth of 1.25MHz makes them the ideal solution for power measurements on N-CDMA (IS-95) signals. The MA2460 sensors must be used with the ML2407/08A power meter. This combination of meter and sensor provides fast signal processing and sampling speeds. Average power,

peak power and crest factor on N-CDMA signals can be measured and displayed. The MA2460 sensors are dual diode sensors and delivers over 80 dB of dynamic range, making them suitable for both open and closed loop power control testing. The sensors internal AC detection circuitry gives a guaranteed noise floor of -60 dBm with typical performance to -70dBm, even when measuring CDMA signals.

Pulses down to 1µs can also be captured and displayed thanks to the sensor rise time of 0.6µs. In profile mode the ML2407A meter can be used to measure average power across narrow pulses, an increasingly common test method for amplifiers in digitally modulated systems.

as HDTV, DAB or QAM modulated radio links.

The sensor architecture ensures that one of the diode pairs is always operating in its square law region. The meter selects the diode pair operating in its square law region and is designed so that even the peaks of CDMA signals are measured accurately. Anritsu's three stage diode pair approach leads to a very much faster measurement time than the two stage approach used in previous generations of average power sensors. No slowing of measurement speed is observed at the switching points, making them transparent to the user.

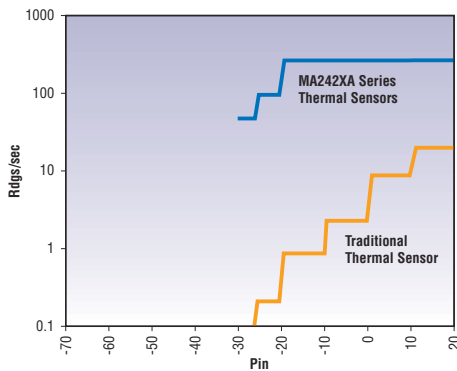

MA2420A/B Thermal Sensors.
Rise and fall times of less than 4 ms improve both settling time and measurement rate by more than two orders of magnitude over most of the useful dynamic range.

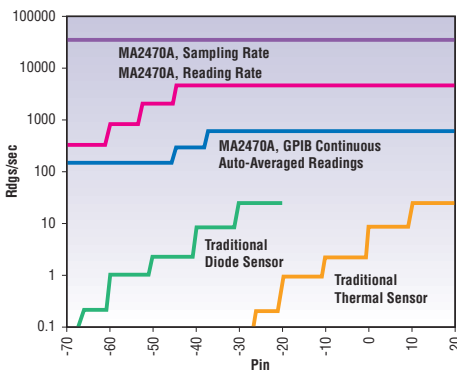

MA2470A Series Power Sensors.
90 dB dynamic range is combined with high speed. Rise time is < 4 µsec. Fall time is < 10 µsec, typical.

Universal Power Sensors

The new MA2480A series Universal Power Sensors will measure any modulated or multi-tone signal thanks to a patented sensor architecture with three diode pairs. Universal power sensors deliver over 80 dB of dynamic range with speed and accuracy. Average power measurements on WCDMA signals can now be made without the need for special power meters. Universal sensors are also ideal for power measurements on other digitally modulated carriers such

as HDTV, DAB or QAM modulated radio links. Universal power sensors are also ideal for applications where multiple signals are present, such as intermodulation measurements and satellite multi carrier power loading measurements.

A unique additional capability of the Anritsu Universal power sensor is the ability to use it as a standard diode sensor for CW measurements. In this mode the fast response of diode sensors is maintained across the full dynamic range of the sensor, meaning that for the majority of users it is the only sensor that they will ever need – a truly Universal Power Sensor.

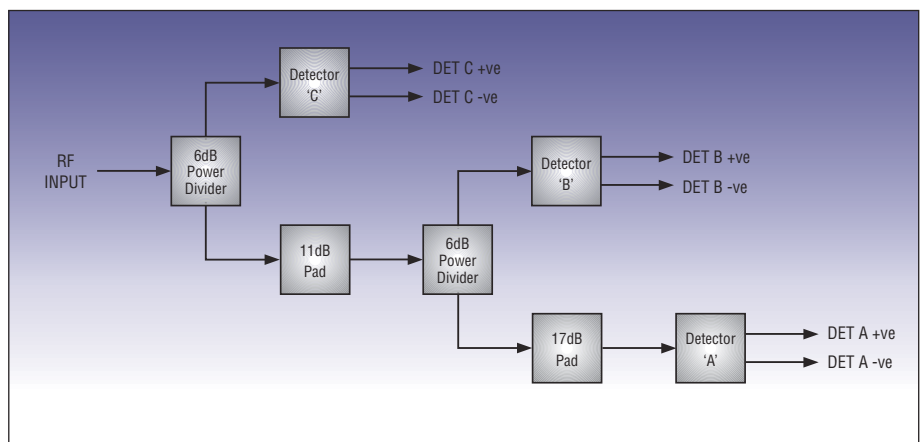

Anritsu's MA2480A series Universal Power Sensors use a unique architecture with three cascaded diode pairs, dividers and attenuators. One of the diode pairs is within its square law region, ensuring true average power measurements of any input signal.

DESIGNED FOR YOUR APPLICATION

Flexibility and Convenience for standard power measurements

The Anritsu ML2400A series of power meters has been designed to offer the best combination of speed, accuracy and flexibility in a low cost package.



True dual channel display shows amplifier output power and gain simultaneously

From its Preset condition the ML2400A series delivers accurate power measurements with a minimum of key strokes. Integral sensor EEPROM's store linearity and calibration factor data. This simplifies measurement set up and reduces human error. Basic power measurements can be made with just two operations; a sensor zero and entry of measurement frequency. Frequent recalibrations are eliminated as calibration data is memorized even after a power down cycle.

The Channel key gives immediate access to the instrument configuration for selection of one or two display channels, with different units or resolution for each. An analog bar graph simplifies manual tuning and peaking of power levels. Audible and visual alarms alert the user to failed measurements when testing against upper and lower limits. The Max/Min hold display feature is perfect for long term drift measurements or for quickly establishing the highest and lowest powers available from a test device.

Anritsu diode sensors deliver stable and repeatable measurements down to -70dBm , thanks to advanced signal processing with automated low level averaging and a very low meter noise floor.

Amplifier Gain Measurements

Power meters are an essential instrument for the precise characterization of amplifier output power and gain. The Anritsu ML2438A is a true dual channel meter, two

independent signal channels eliminate multiplexing. Gain and output power are measured simultaneously. Fast responding thermal or diode sensors respond immediately to changes in power level to reduce total test time.

The combination of 90dB dynamic range sensors, fast settling time and versatile display settings make the ML2438A ideal for amplifier measurements. When an attenuator is required in front of the sensor, power offset tables can be entered into the sensors EEPROM. These tables apply frequency dependant offsets to the measured value, ensuring the best measurement accuracy at all times. When measuring the gain compression

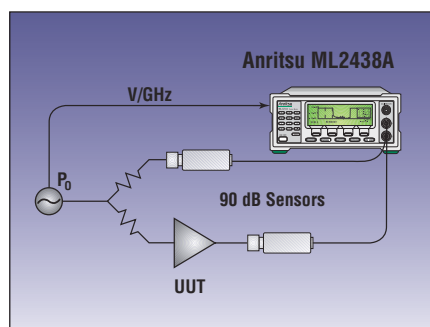

90 dB power sensors simplify test hardware and software. Accuracy is improved because mismatch uncertainty and insertion losses in the switches are eliminated. The dual channel ML2438A speeds execution time by eliminating test system software for multiple meter addresses, cal factor correction, switch control, gain ranging, and meter settling.

of an amplifier across a range of frequencies, the V/GHz input updates the calibration factor as the source frequency is changed. This reduces set up time during manual testing and eliminates the chance of errors.

Power vs Time

Power vs Time mode provides a strip chart display of RF power variation.

Monitor a test device for gain and output power variation over time against; temperature, supply voltage or a component tolerance. Trouble shoot timing glitches or other intermittent power behaviour such as power control in a mobile telephone. Tune circuits for peak performance.

In power vs time mode the graphical display can represent the trace as average, maximum, minimum or both max and min. A time window of 1 minute to 24 hours can be set.

Pulse profiling

A unique feature of the ML2400A series is the ability to display pulsed power signals on a graphical display. Now it is easy to capture and display pulsed power or TDMA signals quickly and easily. In Profile mode the power meter has TTL or edge based trigger functions so that pulses can be captured and displayed in real time. Trigger delay and user settable data

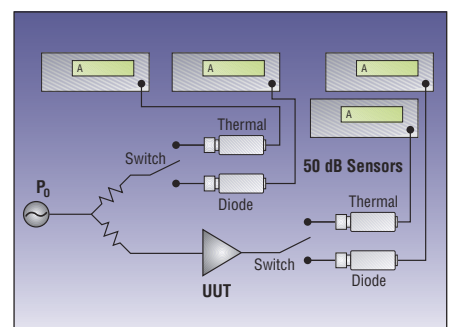

capture timing provide graphical displays from 5µs to 999ms. Measure pulses, detect and avoid switching glitches, view the flatness of a pulse top – it is all possible with the ML2400A series profile mode.

For today's TDMA mobile communications systems such as GSM, PHS, PCS-1900, DCS-1800, DECT and IS-136 the ML2430A can capture and display individual time slots. Using frame triggering it is now possible to measure the average power across a time slot with greater accuracy

production managers and operate with standard power meters.

CDMA systems can have spectral bandwidths of many megahertz. Standard diode sensors are not suitable for measurements on these systems as they give incorrect power measurements when used in their linear region (powers >-25dBm). Thermal sensors can be used as an alternative, but are too slow and limited in dynamic range for the demands of a production environment.

Frequency Sweep and Power Sweep

The Anritsu ML2400A series of power meters are designed to function with Anritsu 69A and 68B synthesized sweep generators to form an integrated test solution for swept power and frequency measurements. Finally, "real-time" tuning speed AND traceable power accuracy are available in a low cost instrument. Easily tune converters, mixers, and transceivers with power meter accuracy. Testing devices with differing input and output frequency is particularly convenient because power sensors are broadband devices. Total power is measured regardless of the device's output frequency. By comparison, receiver based instruments require special calibrations and test set-ups.

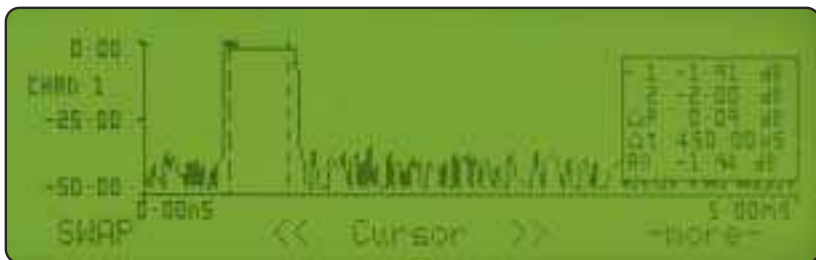

Examine GSM or other TDMA standards slot power. Advanced triggering modes allow frame triggering. Variable gate widths and trigger delay enable precise average power measurements in any single slot.

than ever before, with better accuracy and traceability than is achievable with integrated radio test sets. A marker table displays average power between markers or absolute power at a marker position for simplified slot analysis.

Custom Mode gives a large numeric readout of the power in a pulse within a precisely defined capture window. The window is defined by positioning markers in the graphical display or direct entry of the pulses time data.

Modulated & Multi-tone signals

Anritsu's new Universal power sensor has been specifically designed for the demands of wide bandwidth systems. Universal sensors have no bandwidth restrictions and do not rely on calculated power from sampled waveforms. Universal power sensors deliver 80dB dynamic range with all the speed and accuracy demanded by



***Source Sweep Graphic Display.** Acquire power sweep or frequency sweep data at speeds greater than fifteen sweeps per second (GPIB to PC screen update rate). The meter automatically generates sweep synchronization with Anritsu 68000B or 69000A series Synthesized Sweep Generators.*

OPTIMIZE TEST SYSTEM PERFORMANCE

Lower calibration costs. Higher system throughput. Less programming time. Lower purchase price.

The obvious benefit of a fast power meter is improved test system throughput.

Less obvious are development costs and carrying costs. For example, many power meters claim high speed, but how many offer the advanced trigger controls to make that speed useful? Similarly, a meter lacking sensitivity requires excessive averaging at low power levels.

The MA2470A Series and MA2440A Series power sensors reduce maintenance and calibration costs. For a test system with only 50 dB range power sensors, twice the number of power sensors and four times the meters must be maintained. Switches and cables must be calibrated and their frequency responses logged into the test system software. Additional sensor inventory keeps the test system operating during calibration or repair intervals. Thus, costs are much lower with 90 dB range power sensors.

Anritsu Power Meters replace several types of specialty meters. Many companies use one type of meter for high speed, another for portability, another for low purchase price, and another for thermal sensor compatibility. Standardizing on a single power meter reduces capital and maintenance expense.

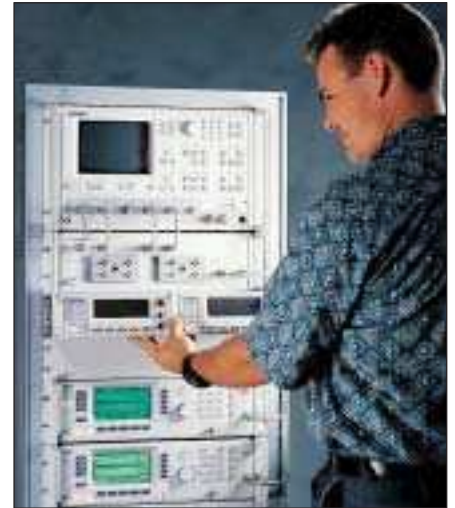

When an existing test system can't be reprogrammed, the ML2400A Series Power Meters emulate older single or dual channel meters. Throughput improvement depends upon the number of power measurements and the minimal use of wait statements within the older code. Typically, test execution speed is two to ten times faster.

**50 GHz Gain Measurement System
With 90 dB Dynamic Range**

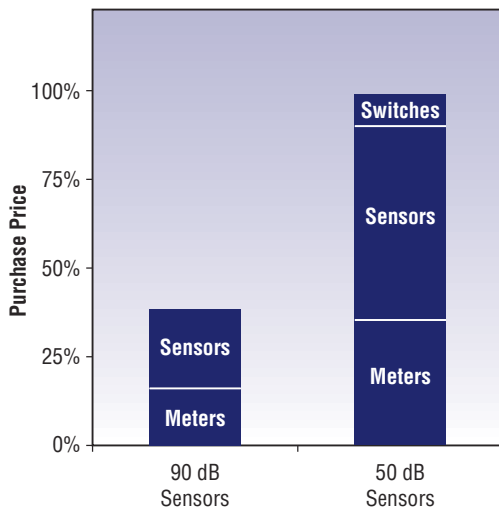

The ML2430A's 90 dB range sensors reduce purchase costs and annual calibration expenses.

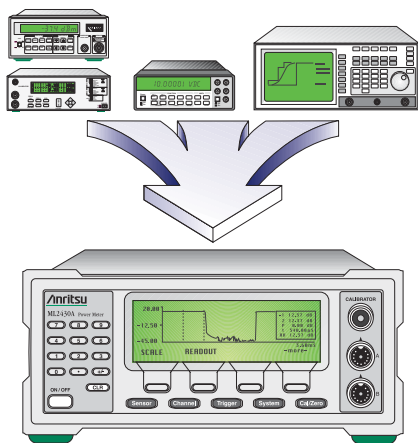

The ML2400A Series Power Meters combine the advantages of speed, accuracy, sensitivity, graphics display, voltage measurement and portability into a single power meter.

VXI and MMS Systems

The ML2400A Series power meters are faster than any VXI or MMS power meter. A single sensor accomplishes more types of measurements over more dynamic range than any offered for card based instrumentation. A single, inexpensive sensor handles peak and CW measurements over a 90 dB range. Thus, the system needs less switch control code, fewer sensors, and the whole system operates faster. Physically, the ML2400A Series occupies less space.

Triggering controls with wide internal trigger ranges eliminate the need for programmatic wait statements for switch and source transient settling times.

The power meter chassis is already RF shielded. That opens another slot in the EMI rack for other microwave equipment. The power sensor connectors are already on the front panel (or rear panel) where they're needed, so there's no need for special bulkhead adapters and extra cables.

Further, the ML2400A Series' built-in display helps trouble-shoot problems quickly. There's no need to press fifteen buttons just to see the power level on 'Uplink # 4.' The pulse profiling and synthesizer compatibility is built-in - avoiding special software.

The power sensor's internal EEPROM allows programmatic activation of User Calibration Factor Tables. This allows a single, standard power sensor to perform high power measurements with attenuators or couplers; no "special" sensors are required.

PORTABLE AND RUGGED FOR FIELD USE

Toughened case. Battery operation. Remote Monitoring... Ideal for use in any location.

The ML2400A Series' brings accuracy and convenience to field service applications.

Performance For Pulses

Individual time slots of GSM, DCS-1800, DECT, IS-136, PCS-1900 and PHS signals can be displayed and measured per the standards' specifications.

Since measurements are performed with the same type of meter used by the equipment manufacturer, service personnel can easily correlate field installation and maintenance data to the manufacturer's production tests. Problem conditions are easily identified.

Simplify Test Procedures

All MA2400A/B power sensors have automated calibration factor correction and internal temperature compensation simplifies field procedures. Operators can focus on solving problems, rather than following lengthy test procedures.

Measurement procedures are further simplified through standardization. As the only power meter to combine fast sensors for profile displays and thermal sensors in one measuring system, service organizations can standardize on a single power meter.

Softkey menus simplify instrument control by making the user interface easier to understand. Status and



selection of meter settings are displayed on the menu as they are entered: hidden selections and special function keys are avoided. A convenient number entry pad avoids the procedural description problems associated with arrow keys used for numerical entries.

Anritsu Power Meters are designed for tough field handling and rugged conditions. The shock resistant polycarbonate case is thoroughly tested. Internal mountings for the battery and circuit boards are reinforced to survive ground impact. An optional front panel cover and softcase are recommended for further environmental protection.

Remote Monitoring By Telephone

For remote trouble-shooting, the full duplex RS-232 remote control automatically calls a pre-entered phone number whenever a limits threshold is exceeded. Just set the limit level, enter the phone number and connect a modem. The ML2400A Series continuously monitors power conditions and calls the host controller when a violation is detected.

The meter's data acquisition settings can adjust to monitor average power or the burst power of specific timeslots. The RS-232 port uses the same commands as the GPIB. Contact your Anritsu representative for PC compatible software.



The optional NiMH battery with "Smart" technology provides 6 hours of continuous operation, accurate fuel gauging, and < 2 hour fast charge cycling. The accessory softcase protects the power meter and accessories from shocks and the weather.

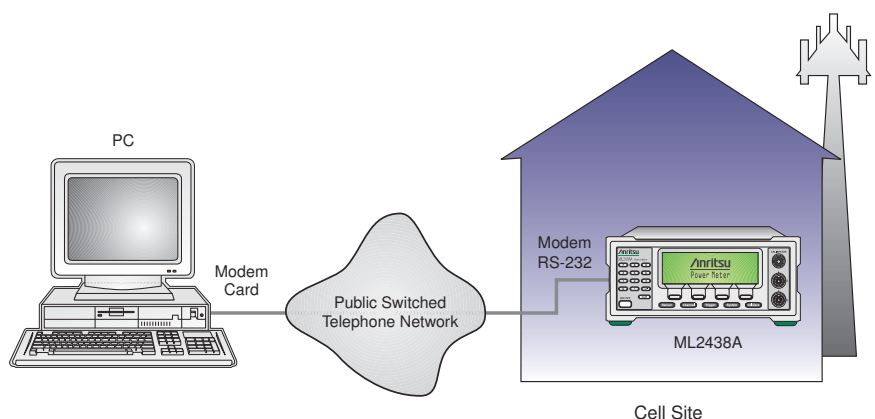

ACCURACY

Power measurement accuracy is a straight forward concept. It has several component parts. Some can be substantially reduced through judicious measurement practice. In the table below, a classic example of measurement accuracy is detailed for each MA2400A/B Series power sensor

Sensor Model Series	MA2420A/B	MA2440A	MA2470A
Instrumentation Accuracy	0.50%	0.50%	0.50%
Sensor Linearity	1.30%	1.80%	1.80%
Noise, 256 Avg.	0.00%	0.00%	0.00%
Zero Set and Drift	0.00%	0.00%	0.00%
Mismatch Uncertainty	3.67%	3.84%	4.49%
Sensor Cal Factor Uncertainty	0.83%	0.79%	0.84%
Reference Power Uncertainty	1.20%	1.20%	1.20%
Reference to Sensor Mismatch Uncertainty	0.23%	0.23%	0.23%
Temperature Linearity, ± 20°C	1.00%	1.00%	1.00%
RSS, Room Temp	4.19%	4.51%	5.09%
Sum of Uncertainties, Room Temp	7.73%	8.36%	9.06%
RSS	4.31%	4.62%	5.18%
Sum of Uncertainties	8.73%	9.36%	10.06%

type. A 16 GHz, 12.0 dBm signal is presumed at a source SWR of 1.5:1.0.

Instrumentation accuracy is the accuracy of the meter. The specification is 0.5% – a very small component of overall measurement accuracy. The error sources which comprise instrumentation accuracy are largely related to linear voltage measurement.

Sensor linearity and temperature linearity describe the relative power

level response over the sensor's dynamic range. When measuring a power level at other than the power level of the absolute reference, which is typically the meter's 0.0 dBm reference 'calibrator', sensor linearity is included in measurement accuracy. Temperature linearity is included when operating the sensor at other than room temperatures. The best way to reduce this error is to first choose power sensors with clearly specified linearity performance.

Noise, Zero Set and Zero Drift impact measurement accuracy at the bottom of a power sensor's dynamic range. Different power sensors have different noise characteristics. Noise can be reduced through additional averaging or longer sample integration times. Additionally, low level averaging can be applied to optimize tradeoffs between dynamic settling, raw noise power deviation, and measuring speed.

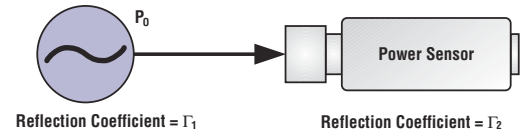

$$\% \text{ Mismatch Uncertainty} = 100 [(1 \pm \Gamma_1 \Gamma_2)^2 - 1]$$

$$\text{dB Mismatch Uncertainty} = 20 \log (1 \pm \Gamma_1 \Gamma_2)$$

Mismatch is easily calculated in either dB or percentage terms from the source's and sensor's respective reflection coefficients.

Mismatch uncertainty is typically the largest component of measurement uncertainty. The error is caused by the differing impedances between the power sensor and the device to which the power sensor is connected. The most convenient method of reducing mismatch uncertainty is to choose power sensors with high return loss; that is, the power sensor's SWR is very close to 1.0. Further improvement results from performing actual measurements of the sensor's return loss with a well calibrated vector network analyzer or other precision return loss measurement technique. Broadband microwave devices like the MA2400A/B Series sensors are assembled in a manner that typically achieves significantly better SWR performance at some frequencies than the performance specifications indicate.

There are three common techniques of reducing source SWR. If the source's S_{22} characteristics can be determined, the mismatch loss can be calculated and the appropriate correction added to

Typical Measurement Uncertainty for 90 dB Power Sensors

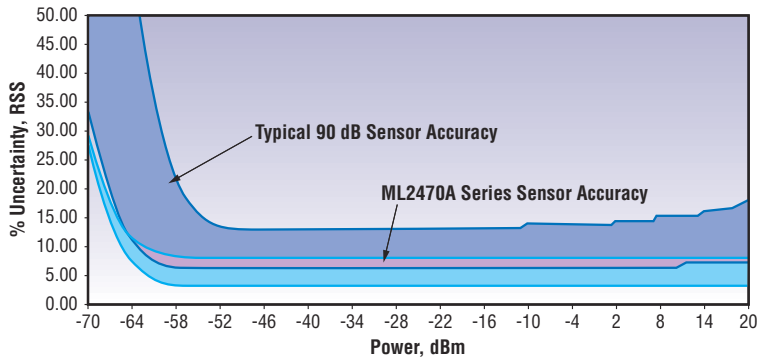

The MA2470A Series Power Sensors' excellent return loss and low noise performance provide industry leading measurement accuracy. Chart shows typical 1.0 to 40 GHz performance excluding error sources for temperature, human error, and test setup frequency response. MA2440A Series High Accuracy Power Sensors further improve accuracy.

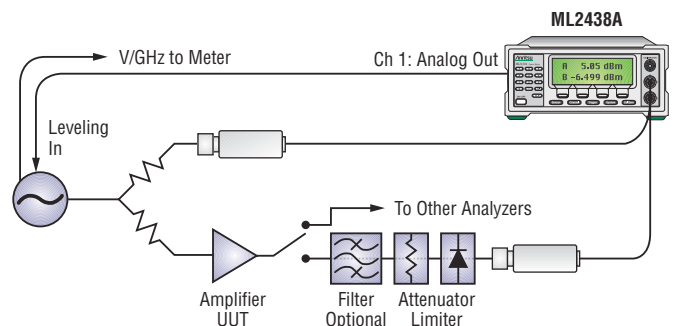

The dual channel ML2438A provides realtime source leveling through a rear panel analog output and simultaneously measures RF power with the other sensor.

the power measurement. Alternately, a 3.0 dB precision attenuator with high return loss can be attached to the source to improve the effective source impedance. Finally, effective source power match can be improved with external power leveling.

Sensor calibration factor uncertainty identifies the accuracy of the sensor's calibration relative to a recognized standard for absolute power level. Sensor calibration factor uncertainty is

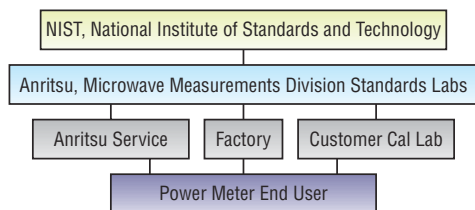

ML2430A Series measurements are NIST traceable.

included in accuracy calculations for any absolute power measurement (in dBm or Watts) and for relative power measurements if the signals are different frequencies.

Reference power uncertainty specifies the maximum possible output drift of the power meter's 50MHz, 0.0 dBm power reference between calibration intervals. The output is traditionally labeled 'calibrator' on a power meter's front panel. Reference accuracy can be improved by using a more accurate or a more recently calibrated reference.

Relative power measurements (in dB or %) can sometimes neglect several sources of error. Reference power uncertainty and sensor to reference mismatch uncertainty do not generally impact relative power measurements. If the measurements are performed at a single frequency, sensor calibration factor uncertainty is negligible. If the source or other device to which the power sensor is connected does not change its reflection characteristics in either magnitude or phase, then mismatch uncertainty can also be neglected under most conditions.

In typical power measurements, the test setup and measurement practices often create larger measurement uncertainties. These errors include exceeding the sensors maximum specified power range, offset errors, poor connector practice, excessive source harmonics and incorrect calibration factor usage.

Offset errors occur because traditional power meters allowed only a fixed value power offset for test setup equipment. The frequency response characteristics from connectors, cables, adapters or attenuators, are assumed to be a single value. For example a '10 dB attenuator' may only be 9.75 dB over some of the frequency range. The 0.25 dB error is approximately 6%, slightly larger than the total accuracy from other error components.

The ML2400A Series Power Meters avoid offset errors by incorporating up to five 200 point offset tables of dB values versus frequency. As frequency information is entered for sensor calibration factor correction, the correct offset level is also interpolated and applied. Compensating for the true frequency response of attenuators, couplers, cables, switches and other test setup devices improves measurement accuracy. When a power sensor connection is preceded with a 1N Series wideband power limiter, the offset table compensates for frequency response – achieving an accurate, "burnout-proof" sensor.

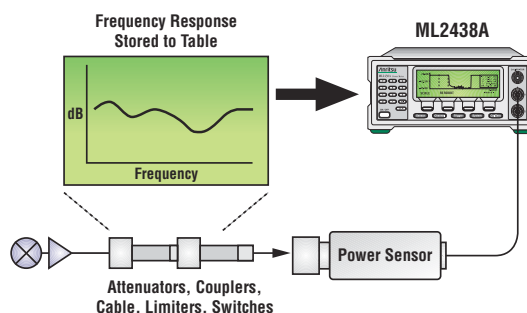

All microwave devices have a frequency response. The ML2400A Series' internal offset table automatically corrects for variation in test setup insertion loss versus frequency. The power sensor's User Calibration Factor Tables accomplish the same function, except the data is stored within the sensor EEPROM rather than the meter.

Connector damage has significant accuracy and repeatability effects. It is the most common cause of sensor damage, but is frequently undetected. Every MA2400A/B Series sensor includes a hex nut connection for application of a calibrated torque wrench. Historical common practice insists that "Finger tight is right." For experienced operators, this may be acceptable. However, an RF connector is like any other precision tool; it has specifications. Particularly in production areas, quality practice dictates that no piece of measurement equipment be used outside of its tolerances. Torque wrenches assure compliance with that quality requirement and results in more consistent measurements.



Hex-nut connectors allow use of a calibrated connector torque wrench, assuring the connector is tightened to its proper tolerances.

ACCESSORIES



ML2419A Range Calibrator

Reduce annual calibration expense with Anritsu's precision range calibrators. The ML2419A Range Calibrator verifies the ML2400A Series Power Meter's measurement channels. The meter's 50 MHz oscillator level is verified by comparison method. When the calibrator is connected, user operation prompts appear on the meter's screen. A verification report is printed using the meter's parallel printer port.



Printer

The Deskjet printer benefits from the print facility of the ML2400A series power meter to give immediate hard copy records of instrument settings, measurement conditions and results. Graphical displays are also output when the meter is in profile mode.



Anritsu and HP Sensor Adapters

Sensor adapters protect your existing investment in power sensors. The MA2497A HP sensor adapter enables connection to HP 8480 series power sensors. MA2499B is for connection to the previous range of Anritsu 4700A and 4600A power sensors. Both sensor adapters have in-built EEPROMS so that calibration factor tables can be stored and recalled from the ML2430A power meter.



Soft Carry Case and Internal Battery

For field use the optional battery gives freedom of operation without access to a power supply. The battery can be charged in the instrument or with the accessory desk top charger. The accessory soft carry case has pockets for all common accessories, making it an ideal carry bag for field use.



Bail Arm and Protective Front Cover

The front panel cover protects the power meter display and connectors from knocks during transit. A bail arm is available for ease of carrying and angling the meter on a workbench.



50MHz Reference Oscillator

When power sensors must be located a long distance from the power meter, the MA2418A Reference Oscillator provides a remote, traceable 0dBm power reference. MA2418A is DC powered from a 16 to 24 volt jack plug.

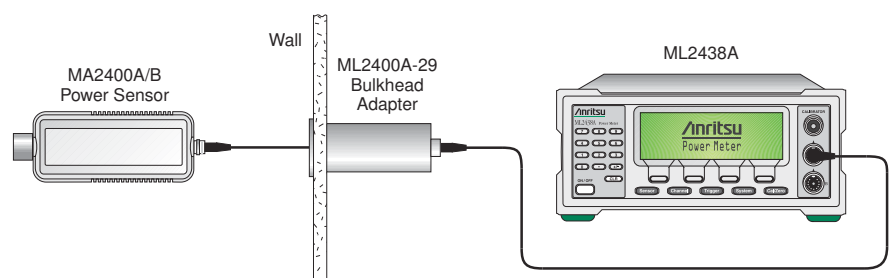

Bulkhead Adapter

When power sensor cables must pass through walls or shielded enclosures, the ML2400A-29 Bulkhead Adapter provides a convenient connection between two sensor cables. When connection to a 50MHz, 0dBm reference is required, the MA2418A Reference Oscillator provides a convenient solution.

Power Attenuators

Model	Frequency Range	Rating	Connectors
42N50-20	dc - 18 GHz	20 dB, 5W, 50 ohm	N male to N female
42N50-30	dc - 18 GHz	30 dB, 50W, 50 ohm	N male to N female
42KC-20	dc - 40 GHz	20 dB, 5W, 50 ohm	K male to K female

Precision Attenuators

Model	Frequency Range	Rating	Connectors
41KC-3	dc - 40 GHz	3 dB, 2W, 50 ohm	K male to K female
41KC-6	dc - 40 GHz	6 dB, 2W, 50 ohm	K male to K female
41KC-10	dc - 40 GHz	10 dB, 2W, 50 ohm	K male to K female
41KC-20	dc - 40 GHz	20 dB, 2W, 50 ohm	K male to K female
41V-3	dc - 60 GHz	3 dB, 2W, 50 ohm	V male to V female
41V-6	dc - 60 GHz	6 dB, 2W, 50 ohm	V male to V female
41V-10	dc - 60 GHz	10 dB, 2W, 50 ohm	V male to V female
41V-20	dc - 60 GHz	20 dB, 2W, 50 ohm	V male to V female

Coaxial RF Limiters

Wideband limiters protect power sensors from damage due to excessive RF power. The limiters have low insertion loss to preserve the power sensor's sensitivity. High quality return loss minimizes mismatch uncertainty degradation and ensures a flatter insertion loss versus frequency characteristic. The insertion loss response should be loaded into the MA2400A/B power sensor's User Calibration Factor Table; however, it is important to note that the limiters large signal response, beginning at about + 10 dBm, is different from the limiter's small signal frequency response.



Inexpensive RF limiters protect sensors against damage from excessive input power.

Model	Frequency Range	Rating	Connectors
1N50C	0.01 - 18 GHz	5W, 50 ohm	N male to N female
1K50A	0.01 - 20 GHz	5W, 50 ohm	K male to K female
1K50B	0.01 - 26 GHz	3W, 50 ohm	K male to K female

Precision Coaxial Adapters

Model	Frequency Range	Connectors
510-90	DC - 3.3 GHz	N male to 7/16 DIN female
510-91	DC - 3.3 GHz	N female to 7/16 DIN female
510-92	DC - 3.3 GHz	N male to 7/16 DIN male
510-93	DC - 3.3 GHz	N female to 7/16 DIN male
K220B	DC - 40 GHz	K male to K male
K222B	DC - 40 GHz	K female to K female
K224B	DC - 40 GHz	K male to K female

Coaxial Adapters

Model	Frequency Range	Connectors
1091-26	DC to 18 GHz	N male to SMA male
1091-27	DC to 18 GHz	N male to SMA female
1091-80	DC to 18 GHz	N female to SMA male
1091-81	DC to 18 GHz	N female to SMA female

Power Splitters

Model	Frequency Range	Connectors
1091-28	DC - 18 GHz	N female - N female/N female
K241B	DC - 26.5 GHz	K male - K female/K female
K241C	DC - 40 GHz	K male - K female/K female
V241C	DC - 60 GHz	V male - V female/V female

Power Dividers

Model	Frequency Range	Connectors
1091-29	DC - 18 GHz	N male - N female/N female
K240B	DC - 26.5 GHz	K female - K female/K female
K240C	DC - 40 GHz	K female - K female/K female
V240C	DC - 60 GHz	V female - V female/V female

Printers

ML2400A-33	Desk-Jet Printer, Portable
2000-661	Black Print Cartridge
2000-662	Rechargeable Battery for Desk-Jet Printer
2000-663	Power Cable (Europe) for Desk-Jet Printer
2000-664	Power Cable (Australia) for Desk-Jet Printer
2000-665	Power Cable (U.K.) for Desk-Jet Printer
2000-667	Power Cable (So. Africa) for Desk-Jet Printer

Precision Loads

Model	Frequency Range	Connectors
28N50-2	DC - 18 GHz	N male
28NF50-2	DC - 18 GHz	N female
28A50-1	DC - 18 GHz	GPC-7
28K50	DC - 40 GHz	K male
28KF50	DC - 40 GHz	K female
28V50B	DC - 67 GHz	V male
28VF50B	DC - 67 GHz	V female

RF Bridges and Open/Shorts

Model	Description	Frequency Range	Connectors
60N50-1	RF Bridge, 46 dB	0.005 - 2.0 GHz	N male
60NF50-1	RF Bridge, 46 dB	0.005 - 2.0 GHz	N female
87A50-1	RF Bridge, 38 dB	2.0 - 18 GHz	GPC-7
22A50	Open/Short	DC - 18 GHz	GPC-7
22N50	Open/Short	DC - 18 GHz	N male
22NF50	Open/Short	DC - 18 GHz	N female

Calibrated Torque Wrenches

Model	Description
01-201	Calibrated torque wrench for K and V connectors
01-204	Calibrated torque wrench for N connector

Precision Waveguide to Coaxial Adapters

Contact your local Anritsu sales office for details of our range of precision waveguide to coaxial adapters.

SPECIFICATIONS

Frequency Range:

100 kHz to 50 GHz (Sensor dependant)

Power Sensors:

Meter specifications apply to MA2400A/B Series Power Sensors. Compatible with MA and MP Series sensors.

Sensor Dynamic Range:

MA2420A/B Series Thermal Sensors:
50 dB

MA2440A Series High Accuracy Power Sensors:
87 dB CW, > 57 dB Peak

MA2460A/B Series Fast Diode Sensors:
80 dB

MA2470A Series Power Sensors:
90 dB CW, > 60 dB Peak

MA2480A Series Universal Sensors:
80 dB

Power Measurement Range:

-70 to +47 dBm (0.1nW to 50W), sensor/attenuator dependent. Use couplers for higher power levels.

Voltage Measurement Range:

0.00 to 20.00 V, nominal

Display Range:

-99.999 to +99.999 dB

Display Resolution:

Selectable from 0.1dB to 0.001dB limited to 0.01 dB in graphical display modes; Linear power units, 3 to 6 digit, 1 - 3 digits selectable to right of decimal nW - W; Voltage, 1 - 2 digits selectable to right of decimal.

Offset Range:

-99.99 to +99.99 dB. Fixed value or frequency dependent table.

Display Units:

dBm, dB, dBr, dBmV, dBuV, W, %, Volts,

Instrumentation Accuracy:

< 0.5 %

Zero Set and Drift:

ML2437/8A < 0.5 % Percent of full scale in most sensitive range, measured over one hour with maximum averaging after one hour warm up at constant temperature.

ML2407/8A < 1.8 % Percent of full scale in most sensitive range, measured over one hour with maximum averaging after one hour warm up at constant temperature.

Noise:

ML2437/8A < 0.5 % Percent of full scale in most sensitive range,

ML2407/8A < 1.8 % Percent of full scale in most sensitive range, both measured over a one minute interval with maximum averaging, two standard deviations at constant temperature after one hour warm up, typical. MA2470A Series, 20 pW typical.

1.00 MW POWER REFERENCE

Frequency:

50MHz nominal

Output Level:

1.00 mW, $\pm 1.2\%$ /Year, $\pm 0.9\%$ RSS, NIST Traceable

Maximum Input:

+ 20 dBm continuous or peak, ± 50 V dc

VSWR:

< 1.04

Connector:

Type N female

SENSOR / CHANNEL CONTROL

Operating modes:

Readout, dual channel. RF power or voltage.

Power Versus Time: single channel graphic of readout data

Profile: single channel RF peak power graphic display for analysis of repetitive pulse or transient waveforms

Source Sweep: Single channel power sweep or frequency sweep

NCDMA Average Power, Peak Power and Crest Factor-ML2407/8A only.

Range Hold:

Current range or selectable 1 through 5.

AVERAGING

Auto-averaging:

Automatically increases moving averaging at low power ranges.

Averaging Types:

Auto, Manual (Moving, Repeat)

Manual Average Range:

1 to 512

Low-Level Averaging:

Low, Medium, and High settings apply post average low pass filter to improve visibility at high display resolution.

Limit Lines:

Fixed value high and low limits with audible, rear panel TTL output, and/or visible Pass/Fail alarm indication. Failure indication can latch for transient failure detection.

Cursors:

Two manually adjustable cursors with power, delta cursor power, between cursor power average, and delta time readout display.

Delta t Resolution:

0.5% of display period or 100ns

TRIGGERING

Trigger Sources:

Internal, External TTL, GPIB, Manual, Continuous

Delay Range:

0.0 to 999.0 Milliseconds

Delay Resolution:

0.5% of display period or 100ns

Internal Trigger Range:

-15 to +20 dBm, all diode sensors. Selectable to -25dBm

Internal Trigger Level Accuracy:

1.0 dB, typical

External Trigger Range:

TTL rising or falling edge trigger. BNC input

Manual Trigger:

Front Panel Softkey

CHANNEL BANDWIDTH

ML2437/38A 100 kHz nominal
ML2407/08A 1.4 MHz nominal

SYSTEM CONFIGURATION

Display:

LCD Graphic display with backlight and adjustable contrast.

Save/Recall:

10 storage registers plus RESET default settings

Secure Mode:

Erases memory information upon power ON. Default condition is Secure Mode OFF.

Rear Panel Inputs/Outputs

Cal Factor Voltage Input (BNC):

Operating Modes:

Voltage: Display voltage reading on selected channel

Voltage proportional to frequency for sensor calibration factor compensation

Blanking Input: TTL levels only. Selectable positive or negative polarity.

Input Range:

0 to 20V

Resolution:

0.5 mV

Control:

Adjustable voltage to frequency Relationship

Analog Output (BNC):

Two outputs configurable to Log or Lin

Operating Modes:

Analog Out: Selectable channel adjusted for calibration factors and other power reading correction settings.

Pass/Fail: Selectable TTL High or Low

Channel output: Near real time analog. Uncalibrated.

AC Modulation Output: Output 1 only.

Dwell Output: Output 2 only

Output Range:

-5.0 to 5.0V

Resolution:

0.1 mV

Trigger Input:

Operating Modes:

External TTL or RF Blanking.

GPIB Interface:

IEEE-488.2 and IEC-625

RS-232:

Supports software download and modem dial-out.

Parallel Printer Output:

Compatible with Deskjet 540 and 340 Models. Other 500 Series and 300 Series and later are typically compatible. Also Canon BJC 80. See manual for DIP switch settings.

GENERAL SPECIFICATIONS

General:

MIL-T28800E, Type 3, class 5, Style E

Display:

Flat panel monochrome LCD graphic with backlight

Operating Temperature Range:

0.0 to +50 °C.

Storage Temperature Range:

-40 to +70 °C

Moisture:

Splash and rain resistant, 95% humidity non-condensing.

Power Requirements:

AC:

90 to 250VAC, 47 to 440Hz, 40VA Maximum

DC:

12 to 24 VDC, Reverse protected to -40V. Maximum input 30V.

Battery:

> 6 hr usable with 3000mAh battery

Replaceable Battery (Option):

3000mAh NiMH

EMI:

Complies with requirements for CE marking.

Warranty:

1 year standard, contact factory for extended warranty options

Dimensions:

8.39 inches (213mm) wide, 3.46 inches (88mm) high, 9.84 inches (390mm) deep

Weight:

<6.6lbs (<3kg)

Power Sensor Specifications

Model	Frequency Range	Dynamic Range (dBm)	SWR	Rise Time ¹ (ms)	Sensor Linearity	RF Conn ²
Standard Diode Sensors						
MA2472B	10 MHz - 18 GHz	- 70 to + 20	< 1.17; 10 - 150 MHz MA2472B Only < 1.90; 10 - 50 MHz < 1.17; 50 - 150 MHz < 1.12; 0.15 - 2 GHz < 1.22; 2 - 12.4 GHz < 1.25; 12.4 - 18 GHz < 1.35; 18 - 32 GHz < 1.50; 32 - 40 GHz < 1.63; 40 - 50 GHz	< 0.004	1.8%, < 18 GHz 2.5%, < 40 GHz 3.5%, < 50 GHz	N (m)
MA2473A	10 MHz - 32 GHz					K (m)
MA2474A	10 MHz - 40 GHz					K (m)
MA2475A	10 MHz - 50 GHz					V (m)
Fast Thermal Sensors						
MA2421A	0.1 MHz - 18 GHz	- 30 to + 20	< 1.10; 0.1 MHz - 2 GHz < 1.15; 2 - 12.4 GHz < 1.20; 12.4 - 18 GHz	< 4.0	1.3%, < 18 GHz 1.5%, < 40 GHz 1.8%, < 50 GHz	N (m)
MA2422B	10 MHz - 18 GHz					N (m)
MA2423B	10 MHz - 32 GHz		K (m)			
MA2424B	10 MHz - 40 GHz		K (m)			
MA2425B	10 MHz - 50 GHz		V (m)			
High Accuracy Diode Sensors						
MA2442B	10 MHz - 18 GHz	- 67 to + 20	< 1.17; 50 - 150MHz MA2442B Only < 1.90; 10 - 50MHz < 1.17; 50 - 150MHz < 1.08; 0.15 - 2GHz < 1.16; 2 - 12.4GHz < 1.21; 12.4 - 18GHz < 1.29; 18 - 32GHz < 1.44; 32 - 40GHz < 1.50; 40 - 50GHz	< 0.004	1.8%, < 18 GHz 2.5%, < 40 GHz 3.5%, < 50 GHz	N (m)
MA2444A	10 MHz - 40 GHz					K (m)
MA2445A	10 MHz - 50 GHz					V (m)
Fast Diode Sensors						
MA2468A ³	10 MHz - 6 GHz	-60 to + 20	< 1.90; 10 - 50 MHz < 1.17; 50 - 150 MHz < 1.12; 0.15 - 2 GHz < 1.22; 2 - 12.4 GHz < 1.25; 12.4 - 18 GHz	< 0.0006	1.8%	N (m)
MA2469B ³	10 MHz - 18 GHz					
Universal Power Sensors						
MA2481B	10 MHz - 6 GHz	-60 to + 20	< 1.17; 10 - 150 MHz < 1.12; 0.15 - 2 GHz < 1.22; 2 - 12.4 GHz < 1.25; 12.4 - 18 GHz	< 0.004 (with option 1 only)	10 MHz to 6 GHz 3% -60 to +20 dBm 6 to 18 GHz 3% -60 to 0 dBm 3.5% 0 to +20 dBm (1.8% CW with option 1)	N (m)
MA2482A	10 MHz - 18 GHz					
MA2480/01	Adds fast CW mode to Universal Power Sensors for high speed measurements of CW signal plus TDMA and pulse measurements.					

1. 0.0 dBm, room temperature.

2. Each MA2400A/B Series sensor incorporates precision RF connectors with hexagon coupling nut for attachment by industry standard torque wrench.

3. MA2460A/B Fast Diode Sensors must be used with ML2407/08A Power Meters for NCDMA and Fast Pulse measurements.

Ordering Information

Models

ML2437A, Power Meter, single input
 ML2438A, Power Meter, dual input
 ML2407A, NCDMA Power Meter, single input
 ML2408A, NCDMA Power Meter, dual input

Included Accessories

Power cord for destination
 One 1.5m sensor cord per meter input
 Operation Manual
 Certificate of Calibration, also included with sensors.

Options and Accessories

ML2400A-01 Rack Mount, single unit
 ML2400A-03 Rack Mount, side-by-side
 ML2400A-05 Front Bail Handle
 ML2400A-06 Rear Mount Input A on ML2437A/07A
 ML2400A-07 Rear Input A and Reference on ML2437A/07A
 ML2400A-08 Rear Mount Inputs A, B and Reference
 ML2400A-09 Rear Mount Inputs A and B on ML2438A/08A
 ML2400A-11 Ni-MH Battery with Desktop Charger
 ML2400A-12 Front Panel Cover
 ML2400A-20 Spare 1.5m Sensor Cable
 ML2400A-21 0.3m Sensor Cable
 ML2400A-22 3m Sensor Cable
 ML2400A-23 5m Sensor Cable
 ML2400A-24 10m Sensor Cable
 ML2400A-25 30m Sensor Cable
 ML2400A-26 50m Sensor Cable
 ML2400A-27 100m Sensor Cable
 ML2400A-29 Bulkhead Adapter
 ML2400A-30 Extra Operation Manual ML2437/8A
 ML2400A-31 Extra Operation/Programming Manual ML2407/8A
 ML2400A-33 Printer
 2300-243 LabVIEW™ Driver and Examples
 760-209 Hardside Transit Case
 D41310 Soft Carry Case with shoulder strap
 10585-00003 Maintenance Manual ML2400A Series
 MA2418A 50 MHz Reference Oscillator with Power Supply
 ML2419A Range Calibrator
 MA2499B Anritsu 4700 & 4600 Series Sensor Adapter
 MA2497A HP8480 Series Sensor Adapter

Options 1 to 5 above are mutually exclusive for any given ML2430A unit.
 Options 6,7, 8 and 9 above are mutually exclusive for any given ML2430A.
 Options 25, 26, 27 can not be used with ML2407/8A



Discover What's Possible™

ANRITSU CORPORATION
 5-10-27, Minamiazabu, Minato-ku, Tokyo
 106, Japan
 Phone: +81-3-3446-1111
 Telex: J34372
 Fax: +81-3-3442-0235

Overseas Subsidiaries

▪ **U.S.A.**
ANRITSU COMPANY
 1155 E. Collins Blvd. Richardson,
 TX 75081, U.S.A.
 Phone: +1-800-ANRITSU
 Fax: +1-972-671-1877

▪ **Canada**
ANRITSU Instruments Ltd.
 4-205 Matheson Blvd. East, Mississauga
 Ontario, L4Z 3E3, Canada
 Phone: +1-905-890-7799
 Fax: +1-905-890-2290

▪ **Brazil**
ANRITSU ELECTRONICA LTDA.
 Praia de Botafogo 440, Sala 2401
 CEP 22250-040, Rio de Janeiro, RJ, Brasil
 Phone: +55-21-527-6922
 Fax: +55-21-537-1456

▪ **U.K.**
ANRITSU LTD.
 200 Capability Green, Luton,
 Bedfordshire LU1 3LU, United Kingdom
 Phone: +44-1582-433200
 Fax: +44-1582-731303

▪ **Germany**
ANRITSU GmbH
 Grafenberger Allee 54-56, D-40237
 Düsseldorf 1, Germany
 Phone: +49-211-9685500
 Fax: +49-211-9685555

▪ **France**
ANRITSU SA
 9, Avenue du Québec, ZA de
 Courtaboeuf
 91951 Les Ulis Cedex, France
 Phone: +33-1-60-92-15-50
 Fax: +33-1-64-46-10-65

▪ **Italy**
ANRITSU SpA
 Via Elio Vittorini, 129, 00144 Roma, Italy
 Phone: +39-6-509-9711
 Fax: +39-6-502-2425
 Fax: +968-791697

▪ **Sweden**
ANRITSU AB
 Botvid Center 145 84 Stockholm, Sweden
 Phone: +46-853470700
 Fax: +46-853470730
 Fax: +91-11-685-2275

▪ **Singapore**
ANRITSU PTE LTD.
 10, Hoe Chiang Road, #07-01/02
 Keppel Towers, Singapore 089315
 Phone: +65-282-2400
 Fax: +65-282-2533

▪ **Hong Kong**
ANRITSU COMPANY LTD.
 Suite 812, 8/F, Chinachem Golden Plaza,
 77 Mody Road, Tsimshatsui East, Kowloon,
 Hong Kong, China
 Phone: +852-2301-4980
 Fax: +852-2301-3545

▪ **Korea**
ANRITSU CORPORATION Limited
 14F Hyunjuk Building, 832-41, Yeoksam-
 Dong, Kangnam-Ku, Seoul, Korea
 Phone: +82-2-782-7151 to 7156
 Fax: +82-2-782-4590

▪ **Spain**
ANRITSU ELECTRÓNICA S.A.
 Europa Empresarial - Edificio Londres -
 Planta 1. a - Oficina 6 Playa de Liencres, 2
 28230 Las Rozas (Madrid) Spain
 Phone: +34 91 640 44 60
 Fax: +34 91 640 44 61

Understanding SWR and Mismatch Uncertainty.

Return Loss, SWR, and reflection coefficient describe a device's impedance match characteristic. When two devices of differing impedance are mated, energy from the output of the source device suffers incomplete transfer to the power sensor.

The partial reflections of microwave energy create a standing wave, hence the term standing wave ratio, SWR. A standing wave's impact upon power measurement accuracy is analogous to moving the power sensor along the transmission line. The load within the power sensor detects more or less signal power depending upon these vector additions and subtractions. Thus, without knowledge of the vector reflection characteristics, it is not possible to know exactly where maxima and minima are mismatch uncertainty.

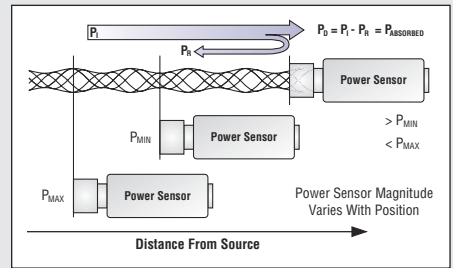

Standing waves are created when impedance mismatch causes RF signal reflections. The magnitude of the standing wave varies along the transmission line as the incident signal and reflected signal add and subtract vectorially.

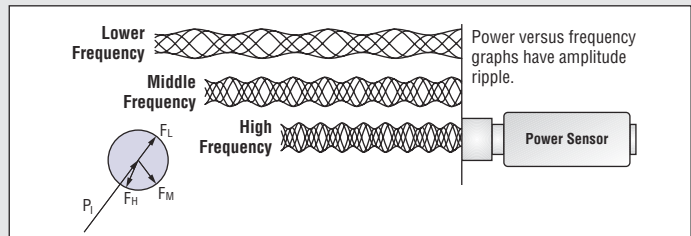

In most test systems, the power sensor is attached at a fixed point on a transmission line. However, the effects of standing waves are still present because the position of the maxima and minima change as the frequency increases. At some point in a swept frequency measurement, in phase addition and subtraction is likely to occur. For this reason, mismatch uncertainty is calculated as a likely worst case value. When performing this calculation it is reasonable to neglect data sheet reflection specifications in favor of actually measuring the reflection magnitudes of the test components. Evaluating the actual reflection magnitudes within a test setup helps identify other causes of measurement variation. This practice is also a very effective means of identifying damage in coaxial connectors.

$$\text{Reflection Coefficient} = \Gamma = \frac{\text{VSWR} - 1}{\text{VSWR} + 1} = 10^{-\text{(Return Loss)} / 20}$$

The numerical values for reflection characteristics are mathematically related.